

# DX<sup>3</sup>

## PERFECT CONTROL OF YOUR INSTALLATION

The DX<sup>3</sup> range  
has a selection  
of electrical  
auxiliaries  
**for monitoring  
and controlling  
circuits remotely**

Auxiliary contacts and fault signal  
contacts, shunt trips, undervoltage  
releases, motorised controls and  
automatic reclosers



### Power overvoltage protection (POP)

Protects your system from serious  
damages caused by Overvoltages

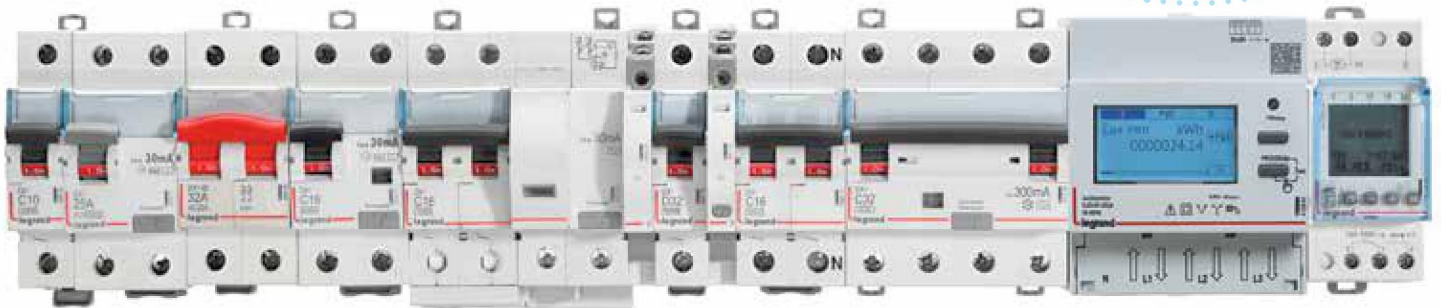

Scan to know more about  
the product.



Marking of auxiliaries (characteristics, connection, mounting)

The fault signal contacts have a test button

The colour code of the indicators on the signalling auxiliaries is the same as that of the remote indicators

DX<sup>3</sup> circuit breakers take up to 3 auxiliaries including one control auxiliary



**OPTIMISED SPACE IN THE DISTRIBUTION BOARD**

Legrand motorised controls are the most compact on the market: 1 module wide. They save a great deal of space inside the distribution board.

DX<sup>3</sup> motorised controls can be used with 1 module per pole devices (circuit breakers, RCBOs and RCCBs) just as easily as auxiliaries.



## DX<sup>3</sup> AC MCBs

Cat.Nos	Nominal Rating	Number of 17.5 mm modules	MRP* ₹ / Unit	Pack
---------	----------------	---------------------------	---------------	------

### MCBs for AC applications till 63 A

10 kA ISI marked as per IS/IEC 60898-1 2002  
 Integrated label holder  
 Sliding bottom clamp  
 Efficient air channels  
 Color coded On/Off indication on dolly  
 Biconnect lower terminals  
 IP 20 protected terminals  
 Sliding shutters  
 Compatible with signal and control Auxiliaries

**DC-80 V per pole - 1 kA**

**C Curve**

**Single pole 240/410 V**

4085 80	0.5	1	502	1/10/120
4085 81	1	1	502	1/10/120
4085 83	2	1	502	1/10/120
4085 84	3	1	502	1/10/120
4085 85	4	1	502	1/10/120
<b>4085 87</b>	6	1	322	1/10/120
<b>4085 90</b>	10	1	322	1/10/120
<b>4085 92</b>	16	1	322	1/10/120
<b>4085 93</b>	20	1	322	1/10/120
<b>4085 94</b>	25	1	322	1/10/120
<b>4085 95</b>	32	1	322	1/10/120
4085 96	40	1	712	1/10/120
4085 97	50	1	712	1/10/120
4085 98	63	1	712	1/10/120



4085 90

### Single pole + Neutral 240 V

4086 02	0.5	2	1308	1/5/60
4086 03	1	2	1308	1/5/60
4086 05	2	2	1308	1/5/60
4086 06	3	2	1308	1/5/60
4086 07	4	2	1308	1/5/60
4086 09	6	2	932	1/5/60
4086 12	10	2	932	1/5/60
<b>4086 14</b>	16	2	932	1/5/60
<b>4086 15</b>	20	2	932	1/5/60
4086 16	25	2	932	1/5/60
<b>4086 17</b>	32	2	932	1/5/60
4086 18	40	2	1518	1/5/60
4086 19	50	2	1518	1/5/60
4086 20	63	2	1518	1/5/60



4086 14

### Double pole 415 V

4086 21	0.5	2	1356	1/40
4086 22	1	2	1356	1/40
4086 24	2	2	1356	1/40
4086 25	3	2	1356	1/40
4086 26	4	2	1356	1/40

\* MRP - Maximum Retail Price Inclusive of all taxes including GST.  
 ♦ For further details on product contact nearest Legrand Sales Office.

## DX<sup>3</sup> AC MCBs

Cat.Nos	Nominal Rating	Number of 17.5 mm modules	MRP* ₹ / Unit	Pack
---------	----------------	---------------------------	---------------	------

<b>4086 28</b>	6	2	990	1/40
<b>4086 31</b>	10	2	990	1/40
<b>4086 33</b>	16	2	990	1/40
<b>4086 34</b>	20	2	990	1/40
<b>4086 35</b>	25	2	990	1/40
<b>4086 36</b>	32	2	990	1/40
4086 37	40	2	1594	1/40
4086 38	50	2	1594	1/40
4086 39	63	2	1594	1/40



4086 37

### Triple pole 415 V

4086 43	0.5	3	1998	1/32
4086 44	1	3	1998	1/32
4086 46	2	3	1998	1/32
4086 47	3	3	1998	1/32
4086 48	4	3	1998	1/32
<b>4086 50</b>	6	3	1616	1/32
<b>4086 53</b>	10	3	1616	1/32
<b>4086 55</b>	16	3	1616	1/32
<b>4086 56</b>	20	3	1616	1/32
<b>4086 57</b>	25	3	1616	1/32
<b>4086 58</b>	32	3	1616	1/32
4086 59	40	3	2468	1/32
4086 60	50	3	2468	1/32
4086 61	63	3	2468	1/32



4086 55

### Triple pole + Neutral 415 V

4086 65	0.5	4	2512	1/32
4086 66	1	4	2512	1/32
4086 68	2	4	2512	1/32
4086 69	3	4	2512	1/32
4086 70	4	4	2512	1/32
4086 72	6	4	2090	1/32
4086 75	10	4	2090	1/32
4086 77	16	4	2090	1/32
4086 78	20	4	2090	1/32
4086 79	25	4	2090	1/32
<b>4086 80</b>	32	4	2090	1/32
<b>4086 81</b>	40	4	3012	1/32
4086 82	50	4	3012	1/32
<b>4086 83</b>	63	4	3012	1/32



4086 77

### Four pole 415 V

4086 84	0.5	4	2502	1/32
4086 85	1	4	2502	1/32
4086 87	2	4	2502	1/32
4086 88	3	4	2502	1/32

Bold Cat.Nos are products normally available with Legrand (India) Stockists.  
 Cat.Nos that are not bold - delivery within 4 - 8 weeks from the date of order.  
 Bold packing quantity is our mandatory packing. Orders to be placed by Legrand (India) Stockist in multiples of the same.

## DX<sup>3</sup> AC MCBs



4086 94

Cat.Nos	Nominal Rating	Number of 17.5 mm modules	MRP* ₹ / Unit	Pack
4086 89	4	4	2502	1/32
4086 91	6	4	2182	1/32
4086 94	10	4	2182	1/32
4086 96	16	4	2182	1/32
4086 97	20	4	2182	1/32
4086 98	25	4	2182	1/32
<b>4086 99</b>	32	4	2182	1/32
<b>4087 00</b>	40	4	3146	1/32
4087 01	50	4	3146	1/32
<b>4087 02</b>	63	4	3146	1/32

## D Curve

### Single pole 240/415 V

4087 06	0.5	1	502	1/10/120
4087 07	1	1	502	1/10/120
4087 09	2	1	502	1/10/120
4087 10	3	1	502	1/10/120
4087 11	4	1	502	1/10/120
<b>4087 12</b>	6	1	424	1/10/120
<b>4087 14</b>	10	1	424	1/10/120
<b>4087 16</b>	16	1	424	1/10/120
<b>4087 17</b>	20	1	424	1/10/120
<b>4087 18</b>	25	1	424	1/10/120
<b>4087 19</b>	32	1	424	1/10/120
4087 20	40	1	764	1/10/120
4087 21	50	1	764	1/10/120
4087 22	63	1	764	1/10/120

### Single pole + Neutral 240 V

4087 26	0.5	2	1320	1/5/60
4087 27	1	2	1320	1/5/60
4087 29	2	2	1320	1/5/60
4087 30	3	2	1320	1/5/60
4087 31	4	2	1320	1/5/60

### Double pole 415 V

4087 32	0.5	2	1368	1/40
4087 33	1	2	1368	1/40
4087 35	2	2	1368	1/40
4087 36	3	2	1368	1/40
4087 37	4	2	1368	1/40
<b>4087 38</b>	6	2	1024	1/40
<b>4087 40</b>	10	2	1024	1/40
<b>4087 42</b>	16	2	1024	1/40
<b>4087 43</b>	20	2	1024	1/40
<b>4087 44</b>	25	2	1024	1/40
<b>4087 45</b>	32	2	1024	1/40
4087 46	40	2	1670	1/40



4087 46

- \* MRP - Maximum Retail Price Inclusive of all taxes including GST.
- ♦ For further details on product contact nearest Legrand Sales Office.

## D Curve



4087 52

Cat.Nos	Nominal Rating	Number of 17.5 mm modules	MRP* ₹ / Unit	Pack
4087 47	50	2	1670	1/40
4087 48	63	2	1670	1/40

### Triple pole 415 V

4087 52	0.5	3	2058	1/32
4087 53	1	3	2058	1/32
4087 55	2	3	2058	1/32
4087 56	3	3	2058	1/32
4087 57	4	3	2058	1/32
4087 58	6	3	1654	1/32
4087 60	10	3	1654	1/32
4087 62	16	3	1654	1/32
4087 63	20	3	1654	1/32
4087 64	25	3	1654	1/32
4087 65	32	3	1654	1/32
4087 66	40	3	2554	1/32
4087 67	50	3	2554	1/32
4087 68	63	3	2554	1/32

### Triple pole + Neutral 415 V

4087 72	0.5	4	2512	1/32
4087 73	1	4	2512	1/32
4087 75	2	4	2512	1/32
4087 76	3	4	2512	1/32
4087 77	4	4	2512	1/32

### Four pole 415 V

4087 78	0.5	4	2504	1/32
4087 79	1	4	2504	1/32
4087 81	2	4	2504	1/32
4087 82	3	4	2504	1/32
4087 83	4	4	2504	1/32
4087 84	6	4	2184	1/32
4087 86	10	4	2184	1/32
4087 88	16	4	2184	1/32
4087 89	20	4	2184	1/32
4087 90	25	4	2184	1/32
4087 91	32	4	2184	1/32
4087 92	40	4	3270	1/32
4087 93	50	4	3270	1/32
4087 94	63	4	3270	1/32



4087 90

### Circuit breakers AC applications 80 - 125 A

10 kA as per IEC 60947-2  
 Integrated label holder  
 Sliding insulating shield  
 Color coded contact indication window  
 IP 20 protected terminals  
 50 sq mm terminals

### \*Single pole 230 V / 400 V

4085 99	80	1.5	2614	1/5/160
---------	----	-----	------	---------

**Bold Cat.Nos** are products normally available with Legrand (India) Stockists. Cat.Nos that are not bold - delivery within 4 - 8 weeks from the date of order. **Bold packing quantity** is our mandatory packing. Orders to be placed by Legrand (India) Stockist in multiples of the same.



### DX<sup>3</sup> MCB



4086 00

Cat.Nos	Nominal Rating	Number of 17.5 mm modules	MRP* ₹ / Unit	Pack
4086 00	100	1.5	2900	1/5/161
4086 01	125	1.5	3102	1/5/162

#### Double pole 230 V / 400 V\*

4086 40	80	3	5816	1/5/60
4086 41	100	3	6200	1/5/60
4086 42	125	3	6752	1/5/60



4086 40

#### Triple pole 400 V\*

4086 62	80	4.5	9176	1/9
4086 63	100	4.5	9774	1/9
4086 64	125	4.5	10742	1/9



4086 63

#### Four pole 400 V\*

4087 03	80	6	11946	1/9
4087 04	100	6	12446	1/9
4087 05	125	6	13944	1/9



4087 05

### DX<sup>3</sup> DC MCBs

#### Circuit breakers DC applications upto 63 A

6 kA as per IEC 60947-2  
Integrated label holder  
Sliding bottom clamp  
Improved air channels  
Color coded On/Off indication on dolly  
Biconnect lower terminals  
IP 20 protected terminals  
Sliding shutters

#### Single pole 250 V

4087 98	0.5	1	760	1/10/120
4087 99	1	1	760	1/10/120
4088 01	2	1	760	1/10/120
4088 02	3	1	760	1/10/120
4088 03	4	1	760	1/10/120
4088 04	6	1	630	1/10/120
4088 06	10	1	630	1/10/120
4088 08	16	1	630	1/10/120
4088 09	20	1	630	1/10/120
4088 10	25	1	630	1/10/120
4088 11	32	1	630	1/10/120
4088 12	40	1	832	1/10/120
4088 13	50	1	832	1/10/120
4088 14	63	1	832	1/10/120



4088 12

#### Double pole 250 V

4088 15	0.5	1	1578	1/5/60
4088 16	1	1	1578	1/5/60
4088 18	2	1	1580	1/5/60
4088 19	3	1	1580	1/5/60
4088 20	4	1	1580	1/5/60
4088 21	6	1	1450	1/5/60

### DX<sup>3</sup> MCB

Cat.Nos	Nominal Rating	Number of 17.5 mm modules	MRP* ₹ / Unit	Pack
---------	----------------	---------------------------	---------------	------

4088 23	10	1	1450	1/5/60
4088 25	16	1	1450	1/5/60
4088 26	20	1	1450	1/5/60
4088 27	25	1	1450	1/5/60
4088 28	32	1	1450	1/5/60
4088 29	40	1	1710	1/5/60
4088 30	50	1	1710	1/5/60
4088 31	63	1	1710	1/5/60

### DX<sup>3</sup> RDSO DC MCB

#### Single pole

4088 32	0.5	1	788	1/10/120
4088 33	1	1	788	1/10/120
4088 34	1.5	1	788	1/10/120
4088 35	1.6	1	788	1/10/120
4088 36	2.5	1	788	1/10/120
4088 37	3	1	572	1/10/120
4088 38	4	1	572	1/10/120
4088 39	5	1	694	1/10/120
4088 40	10	1	694	1/10/120
4088 41	15	1	694	1/10/120
4088 42	20	1	694	1/10/120
4088 43	25	1	694	1/10/120
4088 44	30	1	792	1/10/120
4088 45	35	1	792	1/10/120
4088 46	40	1	870	1/10/120
4088 47	50	1	870	1/10/120
4088 48	60	1	870	1/10/120

### DX<sup>3</sup> isolators

#### Isolators for AC applications upto 125 A

ISI marked as per IEC 60947-3  
Integrated label holder  
Ergonomic red color dolly  
Sliding bottom clamp  
Double break mechanism  
Improved air channels  
Color coded On/Off indication on dolly  
Biconnect lower terminals  
IP 20 protected terminals  
Compatible with signal and control Auxiliaries  
Sliding shutters

#### Double pole 240 V

4065 00	32	2	538	1/5/60
<b>4065 01</b>	40	2	594	1/5/60
<b>4065 02</b>	63	2	784	1/5/60
4065 04	100	2	1078	1/5/60
4065 05	125	2	1224	1/5/60



4065 00

#### Triple pole 415 V

4065 09	32	3	964	1/40
<b>4065 10</b>	40	3	1032	1/40
<b>4065 11</b>	63	3	1222	1/40



4065 10

\* MRP - Maximum Retail Price Inclusive of all taxes including GST.  
♦ For further details on product contact nearest Legrand Sales Office.

Bold Cat.Nos are products normally available with Legrand (India) Stockists. Cat.Nos that are not bold - delivery within 4 - 8 weeks from the date of order. Bold packing quantity is our mandatory packing. Orders to be placed by Legrand (India) Stockist in multiples of the same.

## Isolators for AC applications upto 125 A

Cat.Nos	Nominal Rating	Number of 17.5 mm modules	MRP* ₹ / Unit	Pack
4065 13	100	3	1378	1/40
4065 14	125	3	1588	1/40

### Four pole 415 V

4065 18	32	4	1058	1/32
<b>4065 19</b>	40	4	1314	1/32
<b>4065 20</b>	63	4	1440	1/32
4065 22	100	4	1790	1/32
4065 23	125	4	1974	1/32



4065 20

## DX<sup>3</sup> RCCBs

### RCCBs for AC applications upto 63 A

ISI marked as per IS 12640-1

Integrated label holder

Ergonomic Grey color dolly

Sliding bottom clamp

Compatible with signal and control Auxiliaries

Color coded On/Off indication on dolly

Biconnect lower terminals

IP 20 protected terminals

35 sq mm terminals

Sliding shutters

#### Type -AC

Sensitive to residual alternating currents

Use : standard applications

#### Double pole 240 V

30 mA

<b>4118 51</b>	25	2	3502	1/5/60
<b>4118 52</b>	40	2	4100	1/5/60
4118 53	63	2	4900	1/5/60



4118 57

100 mA

<b>4118 56</b>	25	2	3774	1/5/60
<b>4118 57</b>	40	2	4380	1/5/60
4118 58	63	2	5202	1/5/60

300 mA

4118 61	25	2	3844	1/5/60
4118 62	40	2	4474	1/5/60
4118 63	63	2	5236	1/5/60

### Four pole 415 V

30 mA

4118 76	25	4	4824	1/32
<b>4118 77</b>	40	4	4764	1/32
<b>4118 78</b>	63	4	5528	1/32



4118 77

100 mA

4118 81	25	4	5006	1/32
<b>4118 82</b>	40	4	5036	1/32
<b>4118 83</b>	63	4	5942	1/32



4118 83

300 mA

4118 86	25	4	5126	1/32
<b>4118 87</b>	40	4	5202	1/32
<b>4118 88</b>	63	4	5942	1/32

## RCCBs for AC applications upto 63 A

Cat.Nos	Nominal Rating	Number of 17.5 mm modules	MRP* ₹ / Unit	Pack
---------	----------------	---------------------------	---------------	------

### Type -S

Delayed trip for discrimination with other residual current devices.

Use : for discrimination with a downstream device

#### Double pole 415 V, A-S

300 mA

4118 66	25	2	6630	1/5/60
4118 67	40	2	6960	1/5/60
4118 68	63	2	7128	1/5/60

### Four pole 415 V, A-S

300 mA

4118 91	25	4	7428	1/5/60
4118 92	40	4	7524	1/5/60
4118 93	63	4	7860	1/5/60



4118 93

### Type Hpi

Enhanced immunity to unwanted tripping in environments with disturbances. eg. diesels, computers, printers, etc.

• Detects faults with DC components eg. thyristors, triac etc.

#### Double pole 240 V, HPI

30 mA

4118 71	25	2	7326	1/5/60
4118 72	40	2	7694	1/5/60
4118 73	63	2	7916	1/5/60

### Four pole 415 V, HPI

30 mA

4118 96	25	4	8254	1/32
4118 97	40	4	8514	1/32
4118 98	63	4	8736	1/32



4118 97

## DX<sup>3</sup> RCBOs

### RCBOs assembled for AC applications upto 63 A

ISI marked as per IS 12640-2

Integrated label holder

Ergonomic design

Color coded On/Off indication on dolly

Compatible with signal and control Auxiliaries

Front face indication for earth leakage fault

IP 20 protected terminals

35 sq mm terminals

Sliding shutters

#### Type -AC

Sensitive to residual alternating currents

Use : standard applications

#### Double pole 240 V, AC Type

30 mA

4113 22	6	4	4290	1/32
4113 23	10	4	4248	1/32
<b>4113 24</b>	16	4	4110	1/32
<b>4113 25</b>	25	4	4110	1/32
<b>4113 26</b>	32	4	4500	1/32
<b>4113 27</b>	40	4	5352	1/32
4113 28	63	4	6402	1/32



4113 24

\* MRP - Maximum Retail Price Inclusive of all taxes including GST.

Bold Cat.Nos are products normally available with Legrand (India) Stockists. Cat.Nos that are not bold - delivery within 4 - 8 weeks from the date of order. Bold packing quantity is our mandatory packing. Orders to be placed by Legrand (India) Stockist in multiples of the same.



## RCBOs assembled for AC applications upto 63 A

Cat.Nos	Nominal Rating	Number of 17.5 mm modules	MRP* ₹ / Unit	Pack
---------	----------------	---------------------------	---------------	------

### 100 mA

4113 29	6	4	5344	1/32
4113 30	10	4	5344	1/32
4113 31	16	4	5142	1/32
<b>4113 32</b>	25	4	5048	1/32
<b>4113 33</b>	32	4	5142	1/32
<b>4113 34</b>	40	4	5914	1/32
4113 35	63	4	6846	1/32

### 300 mA

4113 36	16	4	5314	1/32
<b>4113 37</b>	25	4	5314	1/32
<b>4113 38</b>	32	4	5314	1/32
<b>4113 39</b>	40	4	6088	1/32
4113 40	63	4	6972	1/32

### Four pole 415 V, AC Type 30 mA

4113 65	16	7	5794	1/16
4113 66	25	7	5794	1/16
<b>4113 67</b>	32	7	5976	1/16
<b>4113 68</b>	40	7	6066	1/16
<b>4113 69</b>	63	7	7184	1/16

### Four pole 415 V, AC Type 100 mA

4113 70	16	7	6534	1/16
4113 71	25	7	6254	1/16
<b>4113 72</b>	32	7	6320	1/16
<b>4113 73</b>	40	7	6506	1/16
4113 74	63	7	7392	1/16

### Four pole 415 V, AC Type 300 mA

4113 75	16	7	6734	1/16
4113 76	25	7	6500	1/16
<b>4113 77</b>	32	7	6500	1/16
<b>4113 78</b>	40	7	6630	1/16
4113 79	63	7	7520	1/16



4113 79

## RCBOs compact for AC applications upto 32 A, 6 kA

Conforms to IEC 60947  
Integrated label holder  
Ergonomic design  
Color coded On/Off indication on dolly  
Front face indication for earth leakage fault  
IP 20 protected terminals  
35 sq mm terminals  
Sliding shutters

\* MRP - Maximum Retail Price Inclusive of all taxes including GST.

## RCBOs compact for AC applications

Cat.Nos	Description	Number of 17.5 mm modules	MRP* ₹ / Unit	Pack
---------	-------------	---------------------------	---------------	------

### Type -AC

Sensitive to residual alternating currents

Use : standard applications

### Double pole 240 V, AC Type

#### 30 mA

4113 90	6	2	4990	1/32
4113 91	10	2	4990	1/32
<b>4113 92</b>	16	2	4990	1/32
4113 93	20	2	4990	1/32
<b>4113 94</b>	25	2	4990	1/32
<b>4113 95</b>	32	2	5240	1/32



4113 94

#### 300 mA

4113 97	6	2	5142	1/32
4113 98	10	2	5232	1/32
4113 99	16	2	5232	1/32
4114 00	20	2	5232	1/32
4114 01	25	2	5232	1/32
4114 02	32	2	5494	1/32

### Four pole 415 V, AC Type 30 mA

4114 18	10	4	6474	1/16
4114 19	16	4	6474	1/16
4114 20	20	4	6474	1/16
4114 21	25	4	6474	1/16

### Four pole 415 V, AC Type 300 mA

4114 23	10	4	7284	1/16
4114 24	16	4	7284	1/16
4114 25	20	4	7284	1/16
4114 26	25	4	7284	1/16

### Type Hpi

Enhanced immunity to unwanted tripping in environments with disturbances. eg. diesels, computers, printers, etc.

• Detects faults with DC components eg. thyristors, trio etc.

### Double pole 240 V, HPI Type

#### 30 mA

4114 15	25	2	9572	1/32
4114 16	32	2	10116	1/32

### Type A

Sensitive to residual alternating currents and residual currents with a DC component.

Use : special applications

- if it is possible that the fault currents are not purely sinusoidal (rectifier bridge, etc.)

### Four pole 415 V, A Type

#### 30 mA

4114 28	10	4	7656	1/16
4114 29	16	4	7656	1/16
4114 30	20	4	7656	1/16
4114 31	25	4	7656	1/16

Bold Cat.Nos are products normally available with Legrand (India) Stockists. Cat.Nos that are not bold - delivery within 4 - 8 weeks from the date of order. Bold packing quantity is our mandatory packing. Orders to be placed by Legrand (India) Stockist in multiples of the same.

## RCBOs compact for AC applications

Cat.Nos	Nominal Rating	Number of 17.5 mm modules	MRP* ₹ / Unit	Pack
---------	----------------	---------------------------	---------------	------

### Four pole 415 V, A Type 300 mA

4114 33	10	4	8368	1/16
4114 34	16	4	8368	1/16
4114 35	20	4	8368	1/16
4114 36	25	4	8368	1/16

### DX<sup>3</sup> RCD add on module

#### For 125 A

Conform to IEC 61009-1

AC type : detect AC components faults

Hpi type :detect faults with AC and DC components, increased

Immunity to false tripping

For mounting on the right-hand side of 1.5 module per pole DX<sup>3</sup> MCBs

Easy & fast association mechanism

Terminal cover for locking

70 sq mm terminals

### Double pole 240 V, AC Type 30 mA

4105 68	125 A	4	15406	1
---------	-------	---	-------	---

### 100 mA

4105 69	125 A	4	17370	1
---------	-------	---	-------	---

### 300 mA

4105 71	125 A	4	17370	1
---------	-------	---	-------	---

### Four pole 415 V, AC Type 30 mA

4106 25	125 A	4	24316	1
---------	-------	---	-------	---

### 100 mA

4106 26	125 A	4	27172	1
---------	-------	---	-------	---

### 300 mA

4106 29	125 A	4	27172	1
---------	-------	---	-------	---

### Double pole 240 V, HPI type 30 mA

4105 78	125 A	6	19610	1
---------	-------	---	-------	---

### 100 mA

4105 79	125 A	6	21918	1
---------	-------	---	-------	---

### 300 mA

4105 82	125 A	6	21918	1
---------	-------	---	-------	---

### Four pole 415 V, HPI type 30 mA

4106 38	125 A	6	33614	1
---------	-------	---	-------	---

### 100 mA

4106 39	125 A	6	35578	1
---------	-------	---	-------	---

### 300 mA

4106 42	125 A	6	35578	1
---------	-------	---	-------	---

\* MRP - Maximum Retail Price Inclusive of all taxes including GST.



4105 68



4105 78

## DX<sup>3</sup> auxiliaries

Cat.Nos	Description	Number of 17.5 mm modules	MRP* ₹ / Unit	Pack
---------	-------------	---------------------------	---------------	------

### Auxiliaries common for MCBs, Isolators, RCCBs & RCBOs

Easy & fast fixation on site

On site clip on mounting

Clip on fitting on left side

### Signalling auxiliaries

4062 50	Auxiliary changeover switch 6 A	0.5	982	1
4062 52	Fault signalling changeover switch 6 A	0.5	1152	1
4062 64	Changeover + fault signalling switch	1	1824	1



4062 50



4062 52



4062 78



4062 82

### Control auxiliaries

4062 76	Shunt release 12 /48 V AC/ DC	1	2586	1
4062 78	Shunt release 110/415 V V AC	1	2586	1
4062 80	Undervoltage release 24/48 V AC/DC	1	2184	1
4062 82	Undervoltage release 230 V AC	1	2184	1

### Control auxiliaries

4062 86	Pop over voltage release	1	2832	1
4062 90	Motor control 24/48 V AC/ DC	1	12116	1
4062 91	Motor control 110/415 V AC	1	10414	1
4062 93	Motor control 24/48 V AC/ DC	2	19604	1
4062 95	Motor control 110/415 V AC	2	18514	1
4062 88	Automatic resetter	2	13826	1
4062 89	Automatic resetter with autotest	2	17136	1

**Bold Cat.Nos** are products normally available with Legrand (India) Stockists. Cat.Nos that are not bold - delivery within 4 - 8 weeks from the date of order. **Bold packing quantity** is our mandatory packing. Orders to be placed by Legrand (India) Stockist in multiples of the same.



## DX<sup>3</sup> auxiliaries

Cat.Nos	Description	Number of 17.5 mm modules	MRP* ₹ / Unit	Pack
---------	-------------	---------------------------	---------------	------

### Rotary handle

4063 19	Black rotary handle	-	2062	10
4063 20	Yellow/red rotary handle	-	2320	10

### Support for padlock

4063 03	Support for padlock till 63 A	-	496	10
---------	-------------------------------	---	-----	----

### Sealable screw cover

4063 04	Devices upto 63 A	-	490	10
4063 06	For 80-125 A devices	-	856	10

### 1/2 module spacing unit

4063 07	1/2 module spacing unit	0.5	182	10
---------	-------------------------	-----	-----	----

### 5 mm padlock

4063 13	5 mm Padlock	0.5	408	10
---------	--------------	-----	-----	----

### Manual changover switch

Compact design  
Manual switching operation  
Easy to assemble  
Ergonomic design

#### For 1 mod/pole devices

4063 14	Manual change-over switch for DP	1	2458	5
4063 15	Manual change-over switch for TP	1	2838	5
4063 16	Manual change-over switch for FP	1	3092	5

## DX<sup>3</sup> RCD add on module

### with measurement & metering

Cat.Nos	Nominal Rating	Number of 17.5 mm modules	MRP* ₹ / Unit	Pack
---------	----------------	---------------------------	---------------	------

Conform to IEC 61009-1  
Hpi type: detect faults with AC and DC components, increased  
Immunity to false tripping  
Inbuilt measurement/metering option  
Measurement - V, A, F, PF, kWh, KVA, KVAR, THD  
Metering - V, A, F, kWh  
RS 485 port for remote reading  
Di-electric test button inbuilt  
Ergonomic test button  
Scroll button for easy readings  
RLCD display on front facia  
For mounting on the right-hand side of 1.5 module per pole DX3 MCBs

■ Price available on request.

\* MRP - Maximum Retail Price Inclusive of all taxes including GST.

<sup>1</sup> 1P+N and 3P+N: L-N and N-PE protection modes (common and differential modes), the N pole being protected by encapsulated spark gaps. Also called sometimes 1+1 and 3+1

<sup>2</sup> Replaced mid 2015 by Cat.No 4122 80

## DX<sup>3</sup> RCD add on module

Cat.Nos	Nominal Rating	Number of 17.5 mm modules	MRP* ₹ / Unit	Pack
---------	----------------	---------------------------	---------------	------

Easy & fast association mechanism  
70 sq mm terminals

### Adjustable metering, four pole 415 V

4106 57	63 A	7	16842	1
4106 58	125 A	7	30868	1

### Adjustable measurement

4106 59	125 A	7	33996	1
---------	-------	---	-------	---

## DX<sup>3</sup> time switches

Cat.Nos	Description	No. of Modules	MRP* ₹ / Unit	Pack
---------	-------------	----------------	---------------	------

For switching an electric circuit (lighting, heating) ON or OFF at selected times during a pre-programmed time period.

### Alpharex3 Digital Time switches

#### Weekly time switch

Time-saving programming by selection of daily blocks, daily blocks individually adjustable or selection from preset blocks Mo-Fr and Mo-Su  
Permanent ON or OFF

Circuit anticipation

Power reserve 3 years for date, time and switching program

Accuracy +/- 1 sec./Day

**NEW!**

0037 10	Power supply 230 V~ 50/60Hz 1 NO contact 250 V/50 Hz 16 A - cos $\phi$ = 1 28 programmes Shortest switching-time 1 min	1	4950	1
---------	--	---	------	---

### Multiple functions - daily or weekly time switch programme - 5 years clock working reserve

Programme settings: on daily or weekly basis  
15 languages

A programme consists of a on and off time and their assignment to certain days

Option to suspend the programme for a specific period to set-up with start and date

Minimum programme setting: 1 s.

High precision clock:  $\pm$  0.1 sec per day

Particularly suited to irregular cycles:

- security installations (access point, alarms, etc.),
- industrial installations (pump stations, etc.)

Programmed directly on keypad, or using program transfer key Cat.No 4 128 72

Additional functions including random (irregular cycles), hour counters

4126 31	1 output 16 A - 250 V~ - 50/60 Hz 56 programmes 1 Channel	2	5614	1
4126 41	2 output 16 A - 250 V~ - 50/60Hz 2x28 programmes 2 Channel	2	7904	1

4126 41

**Bold Cat.Nos** are products normally available with Legrand (India) Stockists. Cat.Nos that are not bold - delivery within 4 - 8 weeks from the date of order. Bold packing quantity is our mandatory packing. Orders to be placed by Legrand (India) Stockist in multiples of the same.

## DX<sup>3</sup> time switches

Cat.Nos	Description	No. of Modules	MRP* ₹ / Unit	Pack
---------	-------------	----------------	------------------	------

### Digital time switch with Astronomical Function

- For switching on/off lights and other electric devices according to the rising/setting of the sun
- With combination function for creating switching programs in which the devices are switched according to astronomical time and/or fixed preset times
- Daily astronomical calculation of the sunrise/sunset times based on the entered location or location coordinates



4126 54



4126 57

4126 54	1 output 16 A - 250 V~ 50/60 Hz Astronomical function 56 Programmes 1 Channel	2	10030	1
4126 57	2 output 16 A - 250 V~ 50/60 Hz Astronomical function 2x28 programmes 2 Channel	2	11446	1

### Alpharex<sup>3</sup> yearly time switch

- Yearly and weekly time switch with additional astronomical function for all channels
- 84 switching programs per channel, comprising:
  - 28 weekly programs
  - 28 yearly programs
  - 28 special programs (priority program)

4126 30	2 outputs - 230 V~ 50/60 Hz Astronomical function 2 x 3 x 28 = 168 programmes	2	18600	1
---------	---	---	-------	---

Cat.Nos	Description	MRP* ₹ / Unit	Pack
---------	-------------	------------------	------

### Programming accessories

4128 72	<b>Programming transfer key</b> Can be used to store programme settings made: Directly on a multifunction and multi-programme time switch Cat.Nos 4 126 30/31/32/33/41/54/57 (loading on device) -with the programming software installed on a PC running Windows (loading on data loader)	2088	1
4128 73	<b>Programming software Kit</b> Can be used to create, save and transfer program settings for multifunction and multi-program time switches. Data is transferred to the program transfer key using the data loader connected to the USB port of the PC. 4128 73 Kit comprising software on CD-ROM, data loader and transfer key Windows XP, Windows 7, Windows 8 compatible"	4788	1

\* MRP - Maximum Retail Price Inclusive of all taxes including GST.

<sup>1</sup> 1P+N and 3P+N: L-N and N-PE protection modes (common and differential modes), the N pole being protected by encapsulated spark gaps. Also called sometimes 1+1 and 3+1

## DX<sup>3</sup> time switches

Cat.Nos	Description	MRP* ₹ / Unit	Pack
---------	-------------	------------------	------

### Twilight switches

- Light sensitive switches
- Can be used to switch a lighting circuit "ON" and "OFF" based on light conditions (nightfall, daybreak)
- Supplied with IP 65 weatherproof photoelectric cell
- Adjustable from 1 to 100 000 lux

4126 23	Luxo Switch / Light sensitive switch with Lux Sensor - Output 16 A 250 V~	7104	1
---------	---	------	---

### MicroRex analog time switches

Programmed via captive segment  
Power supply: 230 V~ 50/60 Hz  
3-position override switch "ON-AUTO-OFF" on front panel  
Manual changeover to summer/winter time  
1 outlet 16 A - 250 V~ -  $\mu \cos = 1$

### Analogue Time Switch Daily programme

1 segment = 15 minutes  
Accuracy:  $\pm 5$  minutes  
1 outlet 16 A - 250 V~ -  $\mu \cos = 1$

4127 80	Vertical Dial N/O Contact - without working Reserve -Minimum switching time: 15 minutes	1	2900	1
4127 90	Vertical Dial N/O Contact - with 100 h working Reserve -Minimum switching time: 15 minutes	1	3416	1



4128 12

4128 12	Horizontal Dial Changeover Switch - without working Reserve -Minimum switching time: 15 minutes	3	4376	1
4128 13	Horizontal Dial Changeover Switch - with 100 h working Reserve -Minimum switching time: 15 minutes	3	5418	1

### Analogue Time Switch Weekly programme

1 segment = 2 hours  
Accuracy:  $\pm 30$  minutes  
1 outlet 16 A - 250 V~ -  $\mu \cos = 1$

4127 94	Vertical Dial N/O Contact - with 100 h working Reserve -Minimum switching time: 2 hours	1	3782	1
4127 95	Horizontal Dial Changeover Switch - with 100 h working Reserve -Minimum switching time: 4 hours	3	5478	1

## DX<sup>3</sup> contactors

### Power contactors / Modular Contactors CX<sup>3</sup>

Conform to IEC/EN 61095  
Space for power supply busbar on top (up to 25 A)

Bold Cat.Nos are products normally available with Legrand (India) Stockists. Cat.Nos that are not bold - delivery within 4 - 8 weeks from the date of order. Bold packing quantity is our mandatory packing. Orders to be placed by Legrand (India) Stockist in multiples of the same.



## Power contactors / Modular Contactors CX<sup>3</sup>

Cat.Nos	Description	MRP* ₹ / Unit	Pack
---------	-------------	------------------	------

Power contactors with 230 V~ coil and handle  
Manual override for test and repair function, carried out via the handle  
Permanent "ON" or "OFF" without automatic closing of the contactor

4125 44	25 A 2 NO contactor	2080	1
4125 45	40 A 2 NO contactor	3556	1
4125 47	63 A 2 NO contactor	4136	1
4125 48	63 A 2 NC contactor	4136	1
4125 49	40 A 3 NO contactor	5944	1
4125 50	63 A 3 NO contactor	6722	1
4125 51	25 A 4 NO contactor	2456	1
4125 53	40 A 4 NO contactor	6272	1
4125 56	63 A 4 NO contactor	7428	1
4125 57	63 A 4 NC contactor	7498	1

### Signalling auxiliaries for contactors

Auxiliary changeover switch

4124 29	For 1 module contactors 16 A to 25 A	3140	1
4124 30	For 2 module contactors 25 A	3152	1
4124 31	For 40 and 63 A contactors	4136	1

## DX<sup>3</sup> for photovoltaic applications

Cat.Nos	Description	MRP* ₹ / Unit	Pack
---------	-------------	------------------	------

### DC MCBs

Breaking capacity 4.5 kA according to EN 60947-2

#### 800 V= circuit breakers

4144 24	6 A	■	1
4144 25	8 A	■	1
4144 26	10 A	■	1
4144 27	13 A	■	1
4144 28	16 A	■	1
4144 29	20 A	■	1

#### 1000 V= circuit breakers

4144 46	10 A	■	1
4144 47	13 A	■	1
4144 48	16 A	■	1
4144 49	20 A	■	1
4144 50	25 A	■	1
4144 51	32 A	■	1

### Type 2 voltage surge protectors

DC side protection of photovoltaic installations connected to the low voltage network (without energy storage system)

Conforming to UTE guide C 61-740-51 Protection in common mode and residual current mode (Y mode) 1  
Consisting of plug-in modules with LED indicator Red: modules need to be replaced



4122 57

## DX<sup>3</sup> for photovoltaic applications Type 2 voltage surge protectors

Cat.Nos	Description	MRP* ₹ / Unit	Pack
---------	-------------	------------------	------

### Voltage surge protectors

4141 60	600 V= 25KA I <sub>max</sub>	■	1
4141 51	1000 V 40KA I <sub>max</sub>	■	1

### Plug-in replacement module

4141 90	+/- cassette for voltage surge protector 4141 60	■	1
4141 91	T cassette for voltage surge protector 4141 60	■	1
4141 81	+/- and T cassette for voltage surge protector 4141 51	■	1

### DC rotary handle isolating switches

Category of use DC 21B according to EN 60947-3

Double break contacts

#### 600 V= isolating switches

4142 61	16 A	■	1
4142 62	25 A	■	1
4142 63	32 A	■	1

#### 1000 V= isolating switches

4142 81	16 A	■	1
4142 82	25 A	■	1
4142 83	32 A	■	1

### Accessories

4063 05	Pole separation divider	■	1
4063 07	Spacing unit 0.5 unit	■	10

## Class I (T1) low voltage SPDs

Cat.Nos	Number of poles	Neutral position	I <sub>total</sub> (10/350)	Remote status monitoring (FS contact)	Number of modules	MRP* ₹ / Unit
---------	-----------------	------------------	-----------------------------	---------------------------------------	-------------------	------------------

### SPDs for general protection of main distribution-board

#### T1+T2 - limp 12,5 kA/pole T2 - 60 kA

4122 70	1P	-	12.5 kA	No	1	7526
4122 76 <sup>1</sup>	1P+N	Right	25 kA	Yes	2	13244
4122 71	2P	-	25 kA	No	2	14536
4122 72	3P	-	37.5 kA	Yes	3	18020
4122 77 <sup>1</sup>	3P+N	Right	50 kA	Yes	4	24146
4122 73	4P	-	50 kA	No	4	22102

#### T1+T2 - limp 8 kA/pole T2 - 60 kA

4122 50	1P	-	8 kA	No	1	6288
4122 56 <sup>1</sup>	1P+N	Right	16 kA	No	2	11436
4122 51	2P	-	16 kA	No	2	12150
4122 52	3P	-	25 kA	No	3	17118
4122 57 <sup>1</sup>	3P+N	Right	25 kA	No	4	20804
4122 53	4P	-	32 kA	No	4	22048

\* MRP - Maximum Retail Price Inclusive of all taxes including GST.

<sup>1</sup> 1P+N and 3P+N: L-N and N-PE protection modes (common and differential modes), the N pole being protected by encapsulated spark gaps. Also called sometimes 1+1 and 3+1

<sup>2</sup> Replaced mid 2015 by Cat.No 4122 80

Bold Cat.Nos are products normally available with Legrand (India) Stockists. Cat.Nos that are not bold - delivery within 4 - 8 weeks from the date of order. Bold packing quantity is our mandatory packing. Orders to be placed by Legrand (India) Stockist in multiples of the same.

## Class I (T1) low voltage SPDs

Cat.Nos	Number of poles	Neutral position	Total (10/350)	Remote status monitoring (FS contact)	Number of modules	MRP* ₹ / Unit
---------	-----------------	------------------	----------------	---------------------------------------	-------------------	---------------

### SPDs for high risk level installations

#### T1 - limp 50 kA/pole - 440 V~ (IT) - Monobloc

0030 00	1P	-	50 kA	No	2	7464
---------	----	---	-------	----	---	------

#### T1 - limp 35 kA/pole - 440 V± (IT) - Plug-in

4122 80	1P	-	35 kA	Yes	2	16660
---------	----	---	-------	-----	---	-------

#### T1 - limp 25 kA/pole

4122 81 <sup>1</sup>	1P+N	Right	50 kA	Yes	4	21646
4122 82	3P	-	75 kA	Yes	6	51750
4122 83 <sup>1</sup>	3P+N	Right	100 kA	Yes	8	59398

### Replacement plug-in modules

Cat.Nos	Description	MRP* ₹ / Unit	Pack
---------	-------------	---------------	------

4123 02	For SPDs T1+T2 - 8 kA Cat.Nos 4122 50/ 51/52/53/56/57	5972	1
4123 03	For SPDs T1+T2 - 12.5 kA Cat.Nos 4122 70/ 71/72/73/76/77	5632	1
4122 84	For SPDs T1 - 25 kA Cat.Nos 4122 81/82/83 and 0030 20/22/23/27	16212	1
4122 85	N-PE module for SPDs T1 - 25 kA Cat.Nos 4122 81/83 and 0030 23	22002	1
4122 86	For SPDs T1 - 35 kA Cat.No 4122 80	5438	1

### Cabling accessories

4123 10	Ready to use cabling kit consisting of 5 conductors (including the earth conductor) Cross section :16 mm <sup>2</sup> Length : 40 cm For cabling SPDs in industrial enclosures (for EN/IEC 61439 compliance).	1164	1
---------	--	------	---

## Class II (T2) low voltage SPDs

Cat.Nos	Number of poles	Neutral position	Remote status monitoring (FS contact)	Number of modules	MRP* ₹ / Unit	Pack
---------	-----------------	------------------	---------------------------------------	-------------------	---------------	------

### T2 SPDs

#### T2 - I<sub>max</sub> 40 kA/pole

4122 40	1P	-	No	1	4544	1
4122 46 <sup>1</sup>	1P+N	Right	No	2	8652	1
4122 41	2P	-	No	2	8652	1
4122 42	3P	-	Yes	3	12672	1
4122 47 <sup>1</sup>	3P+N	Right	No	4	15422	1
4122 43	4P	-	No	4	15422	1

■ Price available on request.

\* MRP - Maximum Retail Price Inclusive of all taxes including GST.

<sup>1</sup> 1P+N and 3P+N: L-N and N-PE protection modes (common and differential modes), the N pole being protected by encapsulated spark gaps. Also called sometimes 1+1 and 3+1

<sup>2</sup> Replaced mid 2015 by Cat.No 4122 80

## Class II (T2) low voltage SPDs

Cat.Nos	Number of poles	Neutral position	Remote status monitoring (FS contact)	Number of modules	MRP* ₹ / Unit	Pack
---------	-----------------	------------------	---------------------------------------	-------------------	---------------	------

### T2 - I<sub>max</sub> 40 kA/pole - 440 V~ (IT)

4122 30	1P	-	No	1	6018	1
4122 32	3P	-	Yes	3	18020	1
4122 33	4P	-	Yes	4	22102	1

### T2 - I<sub>max</sub> 20 kA/pole

4122 20	1P	-	No	1	3528	1
4122 26 <sup>1</sup>	1P+N	Right	No	2	6768	1
4122 21	2P	-	No	2	6768	1
4122 27 <sup>1</sup>	3P+N	Right	No	4	12602	1
4122 23	4P	-	No	4	12602	1

### Replacement plug-in modules

Cat.Nos	Description	MRP* ₹ / Unit	Pack
---------	-------------	---------------	------

4122 99	For SPDs T2 - 40 kA Cat.Nos 4122 40/ 41/42/43/44/45/ 46/47/66/67	3844	1
4123 00	N-PE module for SPDs T2 - 40 kA Cat.Nos 4122 46/47	7692	1
4123 01	For SPDs T2 - 440 V Cat.Nos 4122 30/32/33	5916	1
4122 97	For SPDs T2 - 20 kA Cat.Nos 4122 20/ 21/23/26/27/62/63	2906	1
4123 98	N-PE module for SPDs T2 - 20 kA Cat.Nos 4122 24/25/26/27	6428	1

## Class II (T2) low voltage SPDs with integrated protection

Cat.Nos	Number of poles	Neutral position	Integrated protection	Number of modules	MRP* ₹ / Unit	Pack
---------	-----------------	------------------	-----------------------	-------------------	---------------	------

### Protection for consumer units

#### T2 self protected SPDs - I<sub>max</sub> 12 kA/pole

0039 51 <sup>1</sup>	1P+N	Left	I <sub>sc</sub> ≤ 6 kA	2	9970	1
0039 53 <sup>1</sup>	3P+N	Left	I <sub>sc</sub> ≤ 6 kA	6	21750	1

### Protection for secondary distribution boards

#### T2 self protected SPDs - I<sub>max</sub> 12 kA/pole

0039 71 <sup>1</sup>	1P+N	Left	I <sub>sc</sub> ≤ 10 kA	2	8254	1
0039 73 <sup>1</sup>	3P+N	Left	I <sub>sc</sub> ≤ 10 kA	6	15614	1

Bold Cat.Nos are products normally available with Legrand (India) Stockists. Cat.Nos that are not bold - delivery within 4 - 8 weeks from the date of order. Bold packing quantity is our mandatory packing. Orders to be placed by Legrand (India) Stockist in multiples of the same.



4122 83

4123 03



4122 84



4122 99



0039 51



0039 53



4122 43



# DPX<sup>3</sup>

PRECISE PROTECTION  
AND MEASUREMENT  
UP TO 1600 A



## TOTAL SELECTIVITY FOR OPTIMUM CONTINUITY OF SERVICE

### DYNAMIC SELECTIVITY

Electronic DPX<sup>3</sup> units have 2-position adjustment:

- Low for normal selectivity level
- High for high selectivity level

When electronic circuit breakers are set to High there is a slight tripping delay, enabling a high level of selectivity to be obtained, even for the highest short-circuit currents.

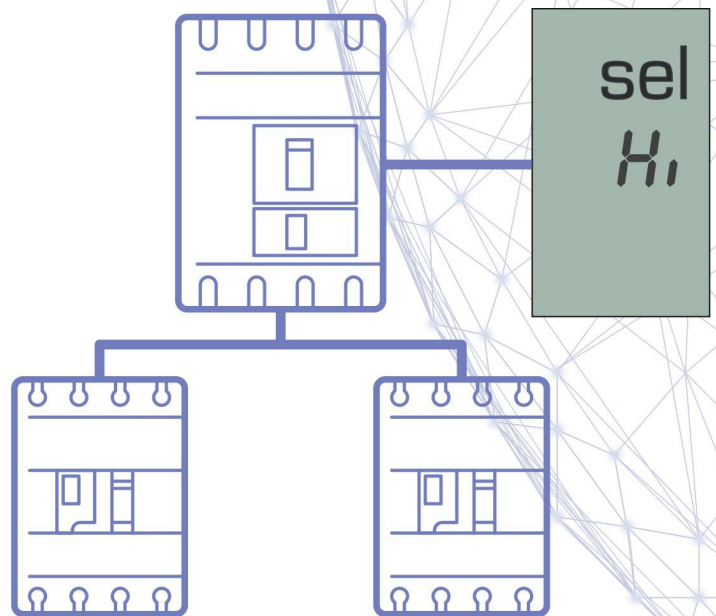

DPX<sup>3</sup> 160



DPX<sup>3</sup> 250



DPX<sup>3</sup> 630



DPX<sup>3</sup> 1600



Scan to know more about  
the product.



NEW FUNCTIONS  
TO SIMPLIFY USE

## Integrated measurement From 40 to 1600 A

The measurement data can also be viewed remotely on a PC equipped with supervision software, via a communication interface.

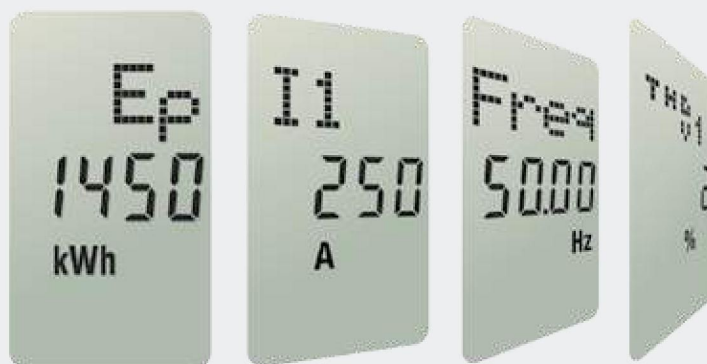



## DRX™ MCCB

Type and frame size	Rated Current (A)	Poles	Cat.Nos	MRP* ₹ / Unit	Pack
---------------------	-------------------	-------	---------	---------------	------

### DRX MCCBs

DRX 100	63 A	3 Pole	0270 39	2604	1/12
Icu = 10 kA	75 A	3 Pole	0270 07	2604	1/12
	100 A	3 Pole	0270 08	2604	1/12
	63 A	4 Pole	0270 29	4072	1/12
	75 A	4 Pole	0270 17	4072	1/12
	100 A	4 Pole	0270 18	4072	1/12

Description	Cat.Nos	MRP* ₹ / Unit	Pack
-------------	---------	---------------	------

### DIN rail adaptor

DRX 100	0271 87	416	1
---------	---------	-----	---

### Rotary handles - Direct

DRX 100	6687 70	1064	1
---------	---------	------	---

### Rotary handles - vary-depth

DRX 100	6687 71	1680	1
---------	---------	------	---

### Padlocking support for operating handle

DRX 100	0271 80	138	1
---------	---------	-----	---

### Connection accessories

Set of 2 shields for 3 pole	0271 81	98	1
-----------------------------	---------	----	---

### Sealable terminal shields (moulded shrouds)

For DRX 100 - 3 pole	0271 83	1360	1
For DRX 100 - 4 pole	0271 84	1358	1

### Cage terminals

For DRX 100 - 3 pole	0271 71	264	1
For DRX 100 - 4 pole	0271 73	278	1

### Electrical accessories

Block with 1 auxiliary (1 AUX)	0271 40	864	1
Block with 1 alarm (1 AL)	0271 41	882	1
Block with 1 auxiliary + 1 alarm (1 AUX + 1 AL)	0271 42	1450	1

### Current shunt coils

200/277 V~ and =	0271 54	1800	1
380/480 V~ and =	0271 55	1800	1

### Undervoltage release coils

200/240 V~	0271 64	2294	1
380/415 V~	0271 65	2328	1

### DRX spreader links

3 Links set for TP	6250 10	192	1
4 Links set for FP	6250 11	288	1

### Metal one way enclosures for MCCB

Cat.Nos	Description	No. of modules	MRP* ₹ / Unit	Pack
5078 05	DRX 100 MCCB enclosure-TP	3	2180	1
5078 06	DRX 100 MCCB enclosure-FP	3	2056	1

\* MRP - Maximum Retail Price Inclusive of all taxes including GST.

# BUSBAR TRUNKING SYSTEM

## FOR INDUSTRIAL, COMMERCIAL, RESIDENTIAL AND SERVICE SECTOR BUILDINGS

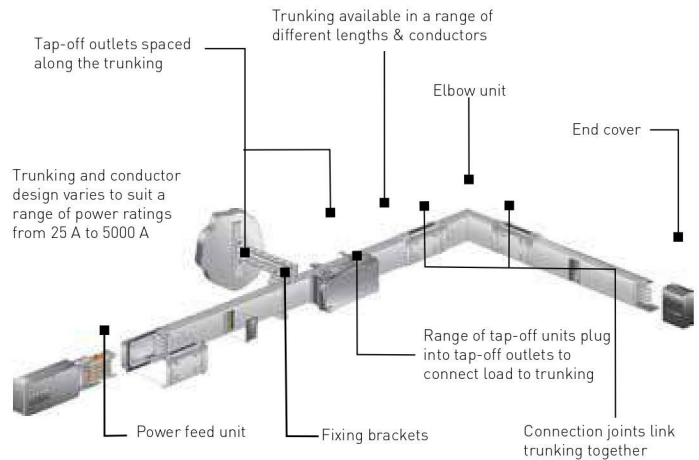

### Exclusive features

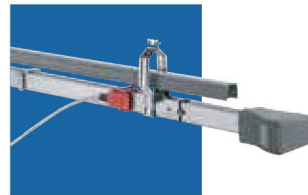

#### Low Power (25 A, 40 A, 63 A)

- Lighting busway
- 2, 4 & 6 pole
- IP 55 protection
- Tap off units at each 0.5 mt interval
- Copper busbars

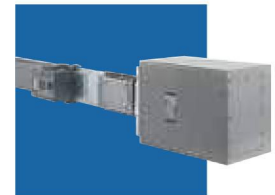

#### Medium Power (63 A - 1000 A)

- Riser mains application
- IP 40, IP 52, IP 55 protection
- Tap off units at each 1 mt interval
- Aluminium & copper busbars



#### Cast Resin Busbar (630 A - 6300 A)

- Fully insulated with epoxy resin
- IP68 suited for outdoor
- Industrial plants, Petrochemical plants, Chemical plants in areas with risk of flooding.



#### Super Compact (630 A - 6300 A)

- Sandwich type construction
- IP 65 protection
- Tap off boxes at each 1 mt interval
- Aluminium & copper busbars



Scan to know more about the product.

Bold Cat.Nos are products normally available with Legrand (India) Stockists. Cat.Nos that are not bold - delivery within 4 - 8 weeks from the date of order. Bold packing quantity is our mandatory packing. Orders to be placed by Legrand (India) Stockist in multiples of the same.



## DPX<sup>3</sup> MCCB

### DPX<sup>3</sup> MCCB with Thermal Magnetic Protection Unit

- Range: 16A – 1250A, Ics=100%Icu, Four Optimum Frames
  - Thermal Adjustable – 0.8 to 1In, Magnetic Adjustable\*\* – 5 to 10In
  - Breaking Capacity# – 16kA, 25kA, 36kA, 50kA, 70kA & 100kA
  - Option for In built or add on module for Earth Leakage Protection##
    - Adjustable sensitivity: 0.03 - 0.3 - 1 - 3 A
    - Adjustable tripping: 0 - 0.3 - 1 - 3s
  - Suitable for Isolation
- \*\* Fixed at 10In for DPX<sup>3</sup> 160  
 # Refer Catalogue for frame wise data  
 ## For DPX<sup>3</sup> 160, DPX<sup>3</sup> 250 and DPX<sup>3</sup> 630 Only

Category	Type	Rated Current (A)	3P			4P		
			Cat.Nos	MRP*/₹/Unit	Pack	Cat.Nos	MRP*/₹/Unit	Pack

#### Thermal Magnetic : O/L & S/C protection

16 KA	DPX <sup>3</sup> 160	16	4200 00	6376	1	4200 10	8496	1	
		25	4200 01	6376	1	4200 11	8496	1	
		40	4200 02	6376	1	4200 12	8496	1	
		63	4200 03	6376	1	4200 13	8496	1	
		80	4200 04	6376	1	4200 14	8496	1	
		100	4200 05	6376	1	4200 15	8496	1	
		125	4200 06	6896	1	4200 16	8550	1	
		160	4200 07	8892	1	4200 17	11194	1	
25 KA	DPX <sup>3</sup> 160	16	4200 40	6908	1	4200 50	9604	1	
		25	4200 41	6908	1	4200 51	9604	1	
		40	4200 42	6908	1	4200 52	9604	1	
		63	4200 43	6908	1	4200 53	9604	1	
		80	4200 44	6908	1	4200 54	9604	1	
		100	4200 45	6908	1	4200 55	9604	1	
		125	4200 46	9996	1	4200 56	12130	1	
		160	4200 47	13366	1	4200 57	15444	1	
		DPX <sup>3</sup> 250	200	4202 08	18038	1	4202 18	21794	1
	250		4202 09	20910	1	4202 19	28176	1	
36 KA	DPX <sup>3</sup> 160	16	4200 80	9080	1	4200 90	11170	1	
		25	4200 81	9080	1	4200 91	11330	1	
		40	4200 82	9080	1	4200 92	11330	1	
		63	4200 83	9080	1	4200 93	11330	1	
		80	4200 84	9080	1	4200 94	11330	1	
		100	4200 85	9080	1	4200 95	11330	1	
		125	4200 86	10206	1	4200 96	13892	1	
		160	4200 87	13722	1	4200 97	15706	1	
		DPX <sup>3</sup> 250	200	4202 38	23794	1	4202 48	30084	1
	250		4202 39	26406	1	4202 49	32218	1	
		DPX <sup>3</sup> 630	320	4220 01	30866	1	4220 06	35054	1
	400		4220 02	30866	1	4220 07	35824	1	
	500		4220 03	38184	1	4220 08	45416	1	
	630		4220 04	38184	1	4220 09	46578	1	
		DPX <sup>3</sup> 1600	800	4222 52	56396	1	4222 57	63448	1
	1000		4222 53	73612	1	4222 58	93058	1	
	1250		4222 54	105180	1	4222 59	111952	1	

■ Price available on request.

\* MRP - Maximum Retail Price Inclusive of all taxes including GST.

Bold Cat.Nos are products normally available with Legrand (India) Stockists. Cat.Nos that are not bold - delivery within 4 - 8 weeks from the date of order. Bold packing quantity is our mandatory packing. Orders to be placed by Legrand (India) Stockist in multiples of the same.

## DPX<sup>3</sup> MCCB

### DPX<sup>3</sup> MCCB with Thermal Magnetic Protection Unit

Category	Type	Rated Current (A)	3P			4P		
			Cat.Nos	MRP*/₹/Unit	Pack	Cat.Nos	MRP*/₹/Unit	Pack
<b>Thermal Magnetic : O/L &amp; S/C protection</b>								
50 KA	DPX <sup>3</sup> 160	16	4201 20	11664	1	4201 30	14696	1
		25	4201 21	11664	1	4201 31	14696	1
		40	4201 22	11664	1	4201 32	14696	1
		63	4201 23	11664	1	4201 33	14696	1
		80	4201 24	11664	1	4201 34	14696	1
		100	4201 25	11664	1	4201 35	14696	1
		125	4201 26	15284	1	4201 36	17612	1
		160	4201 27	17204	1	4201 37	20014	1
	DPX <sup>3</sup> 250	200	4202 68	27542	1	4202 78	34796	1
		250	4202 69	29078	1	4202 79	36190	1
	DPX <sup>3</sup> 630	320	4220 15	33510	1	4220 20	40844	1
		400	4220 16	34232	1	4220 21	40844	1
		500	4220 17	43566	1	4220 22	55018	1
		630	4220 18	43566	1	4220 23	56410	1
	DPX <sup>3</sup> 1600	800	4222 64	59394	1	4222 69	69720	1
		1000	4222 65	92646	1	4222 70	104586	1
		1250	4222 66	136104	1	4222 71	139446	1
	70 KA	DPX <sup>3</sup> 250	100	4206 05	23474	1	4206 15	25910
160			4206 07	29328	1	4206 17	36466	1
200			4206 08	36112	1	4206 18	44434	1
250			4206 09	38374	1	4206 19	46256	1
DPX <sup>3</sup> 630		320	4220 29	39204	1	4220 34	48552	1
		400	4220 30	39210	1	4220 35	48552	1
		500	4220 31	51136	1	4220 36	65876	1
		630	4220 32	53742	1	4220 37	65876	1
DPX <sup>3</sup> 1600		800	4222 76	93700	1	4222 81	108628	1
		1000	4222 77	141890	1	4222 82	200902	1
		1250	4222 78	145360	1	4222 83	231662	1

\* MRP - Maximum Retail Price Inclusive of all taxes including GST.  
 ■ Price available on request.

Bold Cat.Nos are products normally available with Legrand (India) Stockists. Cat.Nos that are not bold - delivery within 4 - 8 weeks from the date of order. Bold packing quantity is our mandatory packing. Orders to be placed by Legrand (India) Stockist in multiples of the same.

## DPX<sup>3</sup> MCCB

### DPX<sup>3</sup> MCCB with Thermal Magnetic Protection Unit

Category	Type	Rated Current (A)	3P			4P				
			Cat.Nos	MRP*/₹/Unit	Pack	Cat.Nos	MRP*/₹/Unit	Pack		
<b>Thermal Magnetic + Electronic earth leakage module</b>										
16 KA	DPX <sup>3</sup> 160	16	-	-	-	4200 30	27658	1		
		25	-	-	-	4200 31	27658	1		
		40	-	-	-	4200 32	27658	1		
		63	-	-	-	4200 33	27658	1		
		80	-	-	-	4200 34	27658	1		
		100	-	-	-	4200 35	27658	1		
		125	-	-	-	4200 36	29176	1		
		160	-	-	-	4200 37	37016	1		
25 KA	DPX <sup>3</sup> 160	16	-	-	-	4200 70	32760	1		
		25	-	-	-	4200 71	32760	1		
		40	-	-	-	4200 72	32760	1		
		63	-	-	-	4200 73	32760	1		
		80	-	-	-	4200 74	32760	1		
		100	-	-	-	4200 75	32760	1		
		125	-	-	-	4200 76	32770	1		
		160	-	-	-	4200 77	38688	1		
	DPX <sup>3</sup> 250	100	-	-	-	4202 25	39686	1		
		160	-	-	-	4202 27	41718	1		
		200	-	-	-	4202 28	43330	1		
		250	-	-	-	4202 29	46338	1		
		36 KA	DPX <sup>3</sup> 160	16	-	-	-	4201 10	39848	1
				25	-	-	-	4201 11	39848	1
40	-			-	-	4201 12	39848	1		
63	-			-	-	4201 13	39848	1		
80	-			-	-	4201 14	39848	1		
100	-			-	-	4201 15	39848	1		
125	-			-	-	4201 16	40062	1		
160	-			-	-	4201 17	47652	1		
DPX <sup>3</sup> 250	100	-	-	-	4202 55	41428	1			
	160	-	-	-	4202 57	48252	1			
	200	-	-	-	4202 58	50610	1			
	250	-	-	-	4202 59	54120	1			
	50 KA	DPX <sup>3</sup> 160	16	-	-	-	4201 50	46142	1	
			25	-	-	-	4201 51	46142	1	
40			-	-	-	4201 52	46142	1		
63			-	-	-	4201 53	46142	1		
80			-	-	-	4201 54	46142	1		
100			-	-	-	4201 55	46142	1		
125			-	-	-	4201 56	49164	1		
160			-	-	-	4201 57	52618	1		
DPX <sup>3</sup> 250		100	-	-	-	4202 85	49714	1		
		160	-	-	-	4202 87	57544	1		
		200	-	-	-	4202 88	60630	1		
		250	-	-	-	4202 89	64418	1		

■ Price available on request.

\* MRP - Maximum Retail Price inclusive of all taxes including GST.

Bold Cat.Nos are products normally available with Legrand (India) Stockists. Cat.Nos that are not bold - delivery within 4 - 8 weeks from the date of order. Bold packing quantity is our mandatory packing. Orders to be placed by Legrand (India) Stockist in multiples of the same.



## DPX<sup>3</sup> MCCB

### DPX<sup>3</sup> MCCB with Electronic S2<sup>#</sup> (LSI)<sup>#</sup> Protection Unit

- Range: 40A – 1600A, Ics=100%Icu, Three Optimum Frames
- Protection against overloads:
  - Ir adjustable from 0.4 to 1 x In
  - tr adjustable from 3 to 30s#
- Protection against short circuits:
  - Isd adjustable from 1.5 to 10 x Ir
  - tsd adjustable from 0 to 0.5s
- Inbuilt Instantaneous Protection:
  - li# – Fixed
- Option for In built or add on module for Earth Leakage Protection##
  - Adjustable sensitivity: 0.03 - 0.3 - 1 - 3 A
  - Adjustable tripping: 0 - 0.3 - 1 - 3s
- Breaking Capacity# – 25kA, 36kA, 50kA, 70kA & 100kA
- In built Display for Current Metering with accuracy of class 1
- Internal Battery with battery measure function
- Communication Ready via COMM Port
- Logical Selectivity Ready (Zone Selective Interlocking)
- Dynamic Selectivity as per Selectivity Charts
- In Built USB Port for Software Diagnosis
- Suitable for Isolation

Category	Type	Rated Current (A)	3P			4P		
			Cat.Nos	MRP*/₹/Unit	Pack	Cat.Nos	MRP*/₹/Unit	Pack

### Electronic S2

25 KA	DPX <sup>3</sup> 250	40	4203 02	18718	1	4203 12	24576	1
		100	4203 05	18718	1	4203 15	24576	1
		160	4203 07	24250	1	4203 17	29004	1
		250	4203 09	31626	1	4203 19	40804	1
36 KA	DPX <sup>3</sup> 250	40	4203 32	20918	1	4203 42	25782	1
		100	4203 35	20918	1	4203 45	25782	1
		160	4203 37	26212	1	4203 47	34978	1
		250	4203 39	35118	1	4203 49	48044	1
	DPX <sup>3</sup> 630	320	4220 57	37574	1	4220 62	46902	1
		400	4220 58	37574	1	4220 63	45920	1
		500	4220 59	42044	1	4220 64	56394	1
		630	4220 60	42924	1	4220 65	57582	1
DPX <sup>3</sup> 1600	800	4223 00	69646	1	4223 06	86006	1	
	1000	4223 01	106640	1	4223 07	157358	1	
	1250	4223 02	128500	1	4223 08	191400	1	
	1600	4223 03	159028	1	4223 09	213606	1	
50 KA	DPX <sup>3</sup> 250	40	4203 62	24188	1	4203 72	32234	1
		100	4203 65	24188	1	4203 75	31710	1
		160	4203 67	29206	1	4203 77	34872	1
		250	4203 69	38972	1	4203 79	47170	1
	DPX <sup>3</sup> 630	320	4220 67	42666	1	4220 72	54414	1
		400	4220 68	42666	1	4220 73	54414	1
		500	4220 69	49852	1	4220 74	62316	1
		630	4220 70	49852	1	4220 75	62316	1
	DPX <sup>3</sup> 1600	800	4223 12	82058	1	4223 18	110650	1
		1000	4223 13	114134	1	4223 19	159072	1
		1250	4223 14	138498	1	4223 20	201880	1
		1600	4223 15	193968	1	4223 21	228346	1

\* MRP - Maximum Retail Price Inclusive of all taxes including GST.  
 ■ Price available on request.

Bold Cat.Nos are products normally available with Legrand (India) Stockists. Cat.Nos that are not bold - delivery within 4 - 8 weeks from the date of order. Bold packing quantity is our mandatory packing. Orders to be placed by Legrand (India) Stockist in multiples of the same.

## DPX<sup>3</sup> MCCB

### DPX<sup>3</sup> MCCB with Electronic S2<sup>#</sup> (LSI)<sup>#</sup> Protection Unit

Category	Type	Rated Current (A)	3P			4P		
			Cat.Nos	MRP*/₹/Unit	Pack	Cat.Nos	MRP*/₹/Unit	Pack

#### Electronic S2

70 KA	DPX <sup>3</sup> 250	40	4206 35	30592	1	4206 45	40470	1
		100	4206 37	30900	1	4206 47	40470	1
		160	4206 38	40466	1	4206 48	46488	1
		250	4206 39	46202	1	4206 49	59628	1
	DPX <sup>3</sup> 630	320	4220 77	54090	1	4220 82	69824	1
		400	4220 78	54090	1	4220 83	69824	1
		500	4220 79	61546	1	4220 84	78488	1
		630	4220 80	61546	1	4220 85	78488	1
	DPX <sup>3</sup> 1600	800	4223 24	107060	1	4223 30	135484	1
		1000	4223 25	150026	1	4223 31	214114	1
		1250	4223 26	179664	1	4223 32	249796	1
		1600	4223 27	241518	1	4223 33	297364	1

#### Electronic S2 + Electronic earth leakage module

25 kA	DPX <sup>3</sup> 250	40	-	-	-	4203 22	56148	1
		100	-	-	-	4203 25	55872	1
		160	-	-	-	4203 27	59936	1
		250	-	-	-	4203 29	70484	1
36 kA	DPX <sup>3</sup> 250	40	-	-	-	4203 52	59998	1
		100	-	-	-	4203 55	59998	1
		160	-	-	-	4203 57	66028	1
		250	-	-	-	4203 59	77172	1
50 kA	DPX <sup>3</sup> 250	40	-	-	-	4203 82	65018	1
		100	-	-	-	4203 85	65018	1
		160	-	-	-	4203 87	70306	1
		250	-	-	-	4203 89	81888	1
70 kA	DPX <sup>3</sup> 250	40	-	-	-	4206 55	82102	1
		100	-	-	-	4206 57	82102	1
		160	-	-	-	4206 58	92778	1
		250	-	-	-	4206 59	127090	1

■ Price available on request.

\* MRP - Maximum Retail Price inclusive of all taxes including GST.

Bold Cat.Nos are products normally available with Legrand (India) Stockists. Cat.Nos that are not bold - delivery within 4 - 8 weeks from the date of order. Bold packing quantity is our mandatory packing. Orders to be placed by Legrand (India) Stockist in multiples of the same.



## DPX<sup>3</sup> MCCB

### DPX<sup>3</sup> MCCB with Electronic Sg (LSIg) Protection Unit

- Range: 40A – 1600A, Ics=100%Icu, Three Optimum Frames
- Protection against Overloads:
  - Ir adjustable from 0.4 to 1 x In
  - tr adjustable from 3 to 30s#
- Protection against Short Circuits:
  - Isd adjustable from 1.5 to 10 x Ir
  - tsd adjustable from 0 to 0.5s
- Inbuilt Instantaneous Protection:
  - li# – Fixed
- Protection against Ground Fault:
  - Ig adjustable from 0.2 to 1 In & OFF
  - tg adjustable from 0.1 to 1s
- Breaking Capacity#– 25kA, 36kA, 50kA, 70kA & 100kA
- In built Display for Current Metering with high accuracy of class 1
- Internal Battery with battery measure function
- Communication Ready via COMM Port
- Logical Selectivity Ready (Zone Selective Interlocking)
- Dynamic Selectivity as per Selectivity Charts
- In Built USB Port for Software Diagnosis
- Switchable Thermal Memory
- Suitable for Isolation

Category	Type	Rated Current (A)	3P			4P		
			Cat.Nos	MRP*/₹/Unit	Pack	Cat.Nos	MRP*/₹/Unit	Pack

#### Electronic Sg

25 KA	DPX <sup>3</sup> 250	40	4205 02	34602	1	4205 12	38730	1
		100	4205 05	34602	1	4205 15	38730	1
		160	4205 07	38498	1	4205 17	42684	1
		250	4205 09	42560	1	4205 19	49800	1
36 KA	DPX <sup>3</sup> 250	40	4205 22	36642	1	4205 32	41278	1
		100	4205 25	36642	1	4205 35	41278	1
		160	4205 27	40458	1	4205 37	42912	1
		250	4205 29	41550	1	4205 39	44008	1
	DPX <sup>3</sup> 630	320	4221 37	51552	1	4221 42	55888	1
		400	4221 38	51552	1	4221 43	55888	1
		500	4221 39	53522	1	4221 44	64406	1
		630	4221 40	53522	1	4221 45	64406	1
DPX <sup>3</sup> 1600	800	4223 96	102924	1	4224 02	124072	1	
	1000	4223 97	136764	1	4224 03	179954	1	
	1250	4223 98	153682	1	4224 04	214312	1	
	1600	4223 99	159792	1	4224 05	241702	1	
50 KA	DPX <sup>3</sup> 250	40	4205 42	36710	1	4205 52	40572	1
		100	4205 45	36710	1	4205 55	40572	1
		160	4205 47	40398	1	4205 57	44190	1
		250	4205 49	41450	1	4205 59	51774	1
	DPX <sup>3</sup> 630	320	4221 47	50274	1	4221 52	59838	1
		400	4221 48	50482	1	4221 53	59838	1
		500	4221 49	57278	1	4221 54	72234	1
		630	4221 50	57278	1	4221 55	72234	1
	DPX <sup>3</sup> 1600	800	4224 08	110206	1	4224 14	123000	1
		1000	4224 09	147994	1	4224 15	187588	1
		1250	4224 10	163514	1	4224 16	211356	1
		1600	4224 11	174464	1	4224 17	248352	1

\* MRP - Maximum Retail Price Inclusive of all taxes including GST.  
 ■ Price available on request.

Bold Cat.Nos are products normally available with Legrand (India) Stockists. Cat.Nos that are not bold - delivery within 4 - 8 weeks from the date of order. Bold packing quantity is our mandatory packing. Orders to be placed by Legrand (India) Stockist in multiples of the same.

## DPX<sup>3</sup> MCCB

### DPX<sup>3</sup> MCCB with Electronic Sg (LSIg) Protection Unit

Category	Type	Rated Current (A)	3P			4P		
			Cat.Nos	MRP*/₹/Unit	Pack	Cat.Nos	MRP*/₹/Unit	Pack
70 kA	DPX <sup>3</sup> 250	40	4206 92	39282	1	4207 02	44524	1
		100	4206 95	39282	1	4207 05	44524	1
		160	4206 97	45924	1	4207 07	51348	1
		250	4206 99	47032	1	4207 09	54038	1
	DPX <sup>3</sup> 630	320	4221 57	61202	1	4221 62	75512	1
		400	4221 58	61202	1	4221 63	75512	1
		500	4221 59	70468	1	4221 64	95892	1
		630	4221 60	70468	1	4221 65	95892	1
	DPX <sup>3</sup> 1600	800	4224 20	112152	1	4224 26	135256	1
		1000	4224 21	156766	1	4224 27	242524	1
		1250	4224 22	218392	1	4224 28	280758	1
		1600	4224 23	294896	1	4224 29	330976	1

## DPX<sup>3</sup> MCCB

### DPX<sup>3</sup> MCCB with Electronic S2\* (LSI)\* & Energy Metering Protection Unit

- Range: 40A – 1600A, Ics=100%Icu, Three Optimum Frames
- Protection against overloads:
  - Ir adjustable from 0.4 to 1 x In
  - tr adjustable from 3 to 30s#
- Protection against short circuits:
  - Isd adjustable from 1.5 to 10 x Ir
  - tsd adjustable from 0 to 0.5s
- Inbuilt Instantaneous Protection:
  - li# – Fixed
- Option for In built or add on module for Earth Leakage Protection##
  - Adjustable sensitivity: 0.03 - 0.3 - 1 - 3 A
  - Adjustable tripping: 0 - 0.3 - 1 - 3s
- Breaking Capacity# – 25kA, 36kA, 50kA, 70kA & 100kA
- Integrated energy metering with accuracy class 2
- Measure for currents, voltage, frequency, power, energy and harmonics
- Internal Battery with battery measure function
- Communication Ready via COMM Port
- Logical Selectivity Ready (Zone Selective Interlocking)
- Dynamic Selectivity as per Selectivity Charts
- In Built USB Port for Software Diagnosis
- Suitable for Isolation

Category	Type	Rated Current (A)	3P			4P		
			Cat.Nos	MRP*/₹/Unit	Pack	Cat.Nos	MRP*/₹/Unit	Pack

### Electronic S2 + Energy metering

25 KA	DPX <sup>3</sup> 250	40	4204 02	36316	1	4204 12	41572	1
		100	4204 05	36316	1	4204 15	41586	1
		160	4204 07	39378	1	4204 17	45078	1
		250	4204 09	42638	1	4204 19	48616	1
36 KA	DPX <sup>3</sup> 250	40	4204 32	39928	1	4204 42	43370	1
		100	4204 35	39928	1	4204 45	43370	1
		160	4204 37	43534	1	4204 47	48670	1
		250	4204 39	47042	1	4204 49	54758	1
	DPX <sup>3</sup> 630	320	4220 97	51160	1	4221 02	60658	1
		400	4220 98	51160	1	4221 03	60658	1
		500	4220 99	55506	1	4221 04	68226	1
		630	4221 00	55506	1	4221 05	68226	1

■ Price available on request.

\* MRP - Maximum Retail Price Inclusive of all taxes including GST.

Bold Cat.Nos are products normally available with Legrand (India) Stockists. Cat.Nos that are not bold - delivery within 4 - 8 weeks from the date of order. Bold packing quantity is our mandatory packing. Orders to be placed by Legrand (India) Stockist in multiples of the same.



**DPX<sup>3</sup> MCCB**  
**DPX<sup>3</sup> MCCB with Electronic S2<sup>#</sup> (LSI)<sup>#</sup> & Energy Metering Protection Unit**

Category	Type	Rated Current (A)	3P			4P		
			Cat.Nos	MRP*/₹/Unit	Pack	Cat.Nos	MRP*/₹/Unit	Pack

**Electronic S2 + Energy metering**

36 KA	DPX <sup>3</sup> 1600	800	4223 48	86952	1	4223 54	97600	1
		1000	4223 49	122058	1	4223 55	171112	1
		1250	4223 50	143222	1	4223 56	193926	1
		1600	4223 51	157042	1	4223 57	214204	1
50 KA	DPX <sup>3</sup> 250	40	4204 62	43750	1	4204 72	47368	1
		100	4204 65	43750	1	4204 75	47368	1
		160	4204 67	48056	1	4204 77	52072	1
		250	4204 69	50810	1	4204 79	58670	1
	DPX <sup>3</sup> 630	320	4221 07	54260	1	4221 12	64566	1
		400	4221 08	54260	1	4221 13	64566	1
		500	4221 09	65868	1	4221 14	73610	1
		630	4221 10	65868	1	4221 15	73610	1
DPX <sup>3</sup> 1600	800	4223 60	91764	1	4223 66	113184	1	
	1000	4223 61	115344	1	4223 67	163506	1	
	1250	4223 62	138154	1	4223 68	204400	1	
	1600	4223 63	171112	1	4223 69	235120	1	
70 KA	DPX <sup>3</sup> 250	40	4206 65	45954	1	4206 75	50856	1
		100	4206 67	45954	1	4206 77	50856	1
		160	4206 68	54922	1	4206 78	58336	1
		250	4206 69	55016	1	4206 79	80012	1
	DPX <sup>3</sup> 630	320	4221 17	65154	1	4221 22	76540	1
		400	4221 18	65154	1	4221 23	75770	1
		500	4221 19	69214	1	4221 24	84294	1
		630	4221 20	69214	1	4221 25	83444	1
DPX <sup>3</sup> 1600	800	4223 72	105202	1	4223 78	130548	1	
	1000	4223 73	141832	1	4223 79	196464	1	
	1250	4223 74	168576	1	4223 80	226880	1	
	1600	4223 75	221810	1	4223 81	280114	1	

**Electronic S2 + Energy Metering + Electronic earth leakage module**

25 KA	DPX <sup>3</sup> 250	40	-	-	-	4204 22	79392	1
		100	-	-	-	4204 25	78624	1
		160	-	-	-	4204 27	83594	1
		250	-	-	-	4204 29	94154	1
36 KA	DPX <sup>3</sup> 250	40	-	-	-	4204 52	80414	1
		100	-	-	-	4204 55	80414	1
		160	-	-	-	4204 57	86638	1
		250	-	-	-	4204 59	95740	1
50 KA	DPX <sup>3</sup> 250	40	-	-	-	4204 82	83564	1
		100	-	-	-	4204 85	85950	1
		160	-	-	-	4204 87	91474	1
		250	-	-	-	4204 89	102878	1
70 KA	DPX <sup>3</sup> 250	40	-	-	-	4206 85	78054	1
		100	-	-	-	4206 87	78054	1
		160	-	-	-	4206 88	85754	1
		250	-	-	-	4206 89	109228	1

\* MRP - Maximum Retail Price Inclusive of all taxes including GST.  
 # Price available on request.

Bold Cat.Nos are products normally available with Legrand (India) Stockists. Cat.Nos that are not bold - delivery within 4 - 8 weeks from the date of order. Bold packing quantity is our mandatory packing. Orders to be placed by Legrand (India) Stockist in multiples of the same.

## DPX<sup>3</sup> MCCB

### DPX<sup>3</sup> MCCB with Electronic Sg (LSIg) & Energy Metering Protection Unit

- Range: 250A – 1600A, Ics=100%Icu, Two Optimum Frames
- Protection against Overloads:
  - Ir adjustable from 0.4 to 1 x In
  - tr adjustable from 3 to 30s
- Protection against Short Circuits:
  - Isd adjustable from 1.5 to 10 x Ir
  - tsd adjustable from 0 to 0.5s
- Inbuilt Instantaneous Protection:
  - li – Fixed
- Protection against Ground Fault:
  - Ig adjustable from 0.2 to 1 In & OFF
  - tg adjustable from 0.1 to 1s
- Breaking Capacity – 36kA, 50kA, 70kA & 100kA
- Integrated energy metering with accuracy class 2
- Measure for currents, voltage, frequency, power, energy and harmonics
- Internal Battery with battery measure function
- Communication Ready via COMM Port
- Logical Selectivity Ready (Zone Selective Interlocking)
- Dynamic Selectivity as per Selectivity Charts
- In Built USB Port for Software Diagnosis
- Switchable Thermal Memory
- Suitable for Isolation

Category	Type	Rated Current (A)	3P			4P		
			Cat.Nos	MRP*/₹/Unit	Pack	Cat.Nos	MRP*/₹/Unit	Pack

#### Electronic Sg + Energy metering

36 KA	DPX <sup>3</sup> 630	320	4221 77	64646	1	4221 82	73512	1
		400	4221 78	64646	1	4221 83	73512	1
		500	4221 79	68604	1	4221 84	83258	1
		630	4221 80	68604	1	4221 85	83258	1
	DPX <sup>3</sup> 1600	800	4224 44	118588	1	4224 50	138154	1
		1000	4224 45	151464	1	4224 51	198998	1
		1250	4224 46	164266	1	4224 52	221810	1
		1600	4224 47	174026	1	4224 53	257300	1
50 KA	DPX <sup>3</sup> 630	320	4221 87	67896	1	4221 92	78378	1
		400	4221 88	67896	1	4221 93	78378	1
		500	4221 89	74726	1	4221 94	91210	1
		630	4221 90	74726	1	4221 95	91210	1
	DPX <sup>3</sup> 1600	800	4224 56	107148	1	4224 62	129284	1
		1000	4224 57	127966	1	4224 63	192660	1
		1250	4224 58	182518	1	4224 64	235752	1
		1600	4224 59	215472	1	4224 65	274412	1
70 KA	DPX <sup>3</sup> 630	320	4221 97	76918	1	4222 02	90724	1
		400	4221 98	76918	1	4222 03	90724	1
		500	4221 99	85906	1	4222 04	110500	1
		630	4222 00	85906	1	4222 05	110500	1
	DPX <sup>3</sup> 1600	800	4224 68	113810	1	4224 74	147664	1
		1000	4224 69	179984	1	4224 75	238820	1
		1250	4224 70	206980	1	4224 76	274068	1
		1600	4224 71	274156	1	4224 77	320368	1

#### Switch disconnecter

	DPX <sup>3</sup> 160	160	4201 98	■	1	4201 99	■	1
	DPX <sup>3</sup> 250	250	4202 99	■	1	4203 00	■	1
	DPX <sup>3</sup> 630	400	4222 16	■	1	4222 18	■	1
		630	4222 17	■	1	4222 19	■	1

■ Price available on request.

\* MRP - Maximum Retail Price Inclusive of all taxes including GST.

Bold Cat.Nos are products normally available with Legrand (India) Stockists. Cat.Nos that are not bold - delivery within 4 - 8 weeks from the date of order. Bold packing quantity is our mandatory packing. Orders to be placed by Legrand (India) Stockist in multiples of the same.

## DPX<sup>3</sup> MCCB

Category	Type	Rated Current (A)	3P			4P		
			Cat.Nos	MRP*/₹/Unit	Pack	Cat.Nos	MRP*/₹/Unit	Pack

### Only magnetic

16 KA	DPX <sup>3</sup> 160	16	4207 10	11918	1	-	-	-
		25	4207 11	11918	1	-	-	-
		50	4207 12	11918	1	-	-	-
		63	4207 13	11918	1	-	-	-
25 KA	DPX <sup>3</sup> 160	16	4207 14	13642	1	-	-	-
		25	4207 15	13642	1	-	-	-
		50	4207 16	13642	1	-	-	-
		63	4207 17	13642	1	-	-	-
36 KA	DPX <sup>3</sup> 250	100	4207 18	23824	1	-	-	-
		160	4207 19	23824	1	-	-	-
		200	4207 20	25190	1	-	-	-
		250	4207 21	26552	1	-	-	-
70 KA	DPX <sup>3</sup> 250	100	4207 22	■	1	-	-	-
		160	4207 23	■	1	-	-	-
		200	4207 24	■	1	-	-	-
		250	4207 25	■	1	-	-	-

### Accessories

Type	Rotary handle				Shunt release											
	Direct		Vary depth		12 V		24 V		48 V		110 V		230 V		400 V	
	Cat.No	MRP	Cat.No	MRP	Cat.No	MRP	Cat.No	MRP	Cat.No	MRP	Cat.No	MRP	Cat.No	MRP	Cat.No	MRP
DPX <sup>3</sup> 160 DPX <sup>3</sup> 250	4201 60	1202	4201 61	1790	4210 12	2188	4210 13	2188	4210 14	2188	4210 15	2188	4210 16	2188	4210 17	2188
DPX <sup>3</sup> 630	4201 62	1924	4201 63	3398	-	-	4222 39	2310	4222 40	2310	4222 41	2310	4222 42	2310	4222 43	2310
DPX <sup>3</sup> 1600	0262 61	3748	0262 83	5746	-	-	-	-	-	-	-	-	-	-	-	-

Type	U/V release													
	12 V		24 V		48 V		110 V		230 V		400 V		480 V	
	Cat.No	MRP	Cat.No	MRP	Cat.No	MRP	Cat.No	MRP	Cat.No	MRP	Cat.No	MRP	Cat.No	MRP
DPX <sup>3</sup> 160 DPX <sup>3</sup> 250	4210 18	2734	4210 19	2734	4210 20	2734	4210 21	2708	4210 22	2708	4210 24	2708	4210 25	2708
DPX <sup>3</sup> 630 DPX <sup>3</sup> 1600	-	-	4222 45	3000	4222 46	3000	4222 47	2974	4222 48	2974	4222 49	2974	-	-

Type	Rated Current (A)	Spreaders**				Motor Operator									
		3P (Set of 3)		4P (Set of 4)		24-230V Side		24V		48V		110V		230V	
		Cat.No	MRP	Cat.No	MRP	Cat.No	MRP	Cat.No	MRP	Cat.No	MRP	Cat.No	MRP	Cat.No	MRP
DPX <sup>3</sup> 160		6250 02	442	6250 06	662	4210 60	30862	4210 61	27724	4210 61	27724	4210 61	27724	4210 61	27724
DPX <sup>3</sup> 250		6250 14	638	6250 18	848	-	-	-	-	-	-	-	-	-	-
DPX <sup>3</sup> 630		6250 04	1470	6250 08	1996	-	-	0261 40	57647	0261 41	57647	-	-	0261 44	44294
DPX <sup>3</sup> 1600	Upto 1250 A	4226 24	■	4226 25	■	-	-	0261 24	109844	0261 25	94781	0261 26	■	0261 23	52018
	Above 1600 A	0262 73	■	0262 74	■	-	-	0261 19	109844	0261 28	94781	0261 29	■	0261 27	55514

\* MRP - Maximum Retail Price Inclusive of all taxes including GST.  
 ■ Price available on request.

Bold Cat.Nos are products normally available with Legrand (India) Stockists.  
 Cat.Nos that are not bold - delivery within 4 - 8 weeks from the date of order.  
 Bold packing quantity is our mandatory packing. Orders to be placed by Legrand (India) Stockist in multiples of the same.



## DPX<sup>3</sup> 160 equipment and mounting accessories



4210 40

Cat.Nos	Description	MRP* ₹ / Unit	Pack
---------	-------------	---------------------	------

### Equipment for plug-in version

4210 40	For DPX <sup>3</sup> 160 - 3P	■	1
4210 41	For DPX <sup>3</sup> 160 - 4P with or without earth leakage module	■	1
4210 44	Set of connectors for auxiliary contacts	■	1
4210 45	Key barrel and flat key for Padlocks	■	1
4210 46	Key barrel and star key for Padlocks	■	1
4210 47	Padlock accessory	■	1

### Connection accessories

4210 26	Set of 3 terminals for High capacity cage terminals	7044	1
4210 27	Set of 4 terminals for High capacity cage terminals	9310	1
4210 70	Set of 3 insulated shields	156	1
4210 28	Set of 3 terminals Screw terminals for copper bars connection	800	1
4210 29	Set of 4 terminals Screw terminals for copper bars connection	956	1
6250 02	Set of 3 spreaders for DPX <sup>3</sup> 160 3P	442	1
6250 06	Set of 4 spreaders for DPX <sup>3</sup> 160 4P	662	1

### Connection accessories

4210 36	Set of 3 rear terminals for DPX <sup>3</sup> 160 3P	3768	1
4210 37	Set of 4 rear terminals for DPX <sup>3</sup> 160 4P	5052	1

### Sealable terminal shields

#### For front terminals

4210 54	For DPX <sup>3</sup> 160 3P	4112	1
4210 55	For DPX <sup>3</sup> 160 3P	4344	1

#### For rear terminals

4210 50	For DPX <sup>3</sup> 160 3P	2600	1
4210 51	For DPX <sup>3</sup> 160 4P	2312	1

### Fixing plates

4210 71	For DPX <sup>3</sup> 160 3P / 4P without earth leakage module	380	1
4210 73	For DPX <sup>3</sup> 160 4P with earth leakage module	934	1
4210 68	For DPX <sup>3</sup> 160 3P / 4P with side mounting motor operator	956	1

■ Price available on request.

\* MRP - Maximum Retail Price Inclusive of all taxes including GST.

MCCB Prices are without spreaders. For ordering spreaders refer page no. 21

## DPX<sup>3</sup> 160 and 250 common auxiliaries and accessories



4210 58

Cat.Nos	Description	MRP* ₹ / Unit	Pack
---------	-------------	---------------------	------

### Supply inverter type

4210 58	For fixed version	3472	1
4210 59	For plug-in and draw-out version	3700	1

### Rotary handles

<b>4201 60</b>	Standard handle for thermal magnetic DPX <sup>3</sup>	1202	1
<b>4201 61</b>	Vari-depth standard handles	1790	1
4201 67	Key Lock for VD RH DPX <sup>3</sup> 160 & 250	2110	1
4201 65	Key Lock for DIR RH Type A DPX <sup>3</sup> 160 & 250	2052	1
4201 68	Key Lock for VD RH Type A DPX <sup>3</sup> 160 & 250	2110	1
4201 66	Key Lock for DIR RH Type B DPX <sup>3</sup> 160 & 250	2052	1
4201 69	Key Lock for VD RH Type B DPX <sup>3</sup> 160 & 250	2110	1

### Motor-driven handles

4210 60	Side motor operator	30862	1
4210 61	Front motor operator	27724	1
4210 62	Ronis key barrel for front motor operator	■	1
4210 63	Profalux key barrel for front motor operator	■	1

## DPX<sup>3</sup> 160 and 250 common auxiliaries and accessories

4210 64	Padlock for front motor operator	2148	1
4210 65	Ronis key barrel for side motor operator	16708	1
4210 66	Profalux key barrel for side motor operator	15180	1
4210 67	Padlock for side motor operator	2280	1

### Auxiliary contacts

<b>4210 10</b>	1 N/C + 1 N/O auxiliary contact for rotary handles	1258	1
<b>4210 11</b>	Auxiliary contact or fault signalling contact	982	1
4210 48	Signalling contact plugged-in/drawn-out (for DPX <sup>3</sup> plug-in version)	■	1

### Locking accessory

4210 49	Padlock for locking in "open" position	1080	1
---------	---	------	---

### Communication interface

4210 75	Modbus	14260	1
---------	--------	-------	---

**Bold Cat.Nos** are products normally available with Legrand (India) Stockists. Cat.Nos that are not bold - delivery within 4 - 8 weeks from the date of order. Bold packing quantity is our mandatory packing. Orders to be placed by Legrand (India) Stockist in multiples of the same.

## DPX<sup>3</sup> 250

### equipment and mounting accessories

Cat.Nos	Description	MRP* ₹ / Unit	Pack
---------	-------------	------------------	------

#### Equipment for plug-in version

4210 42	For DPX <sup>3</sup> 250 - 3P	■	1
4210 43	For DPX <sup>3</sup> 250 - 4P with or without earth leakage module	■	1
4210 44	Set of connectors for auxiliary contacts	■	1
4210 45	Key barrel and flat key N° ABA90GEL6149 for Padlocks	■	1
4210 46	Key barrel and star key N° HBA90GPS6149 for Padlocks	■	1
4210 47	Padlock accessory	■	1

#### Connection accessories

4210 30	Set of 3 cage terminals	2840	1
4210 31	Set of 4 cage terminals	3698	1
4210 70	Set of 3 phase barriers	156	1

#### Connection accessories

6250 14	Set of 3 spreaders for DPX <sup>3</sup> 250 3P	638	1
6250 18	Set of 4 spreaders for DPX <sup>3</sup> 250 4P	848	1
4210 38	Set of 3 rear terminals for DPX <sup>3</sup> 250 3P	3806	1
4210 39	Set of 4 rear terminals for DPX <sup>3</sup> 250 4P	5124	1

#### Sealable terminal shields

##### For front terminals

4210 56	For DPX <sup>3</sup> 250 3P	4260	1
4210 57	For DPX <sup>3</sup> 250 4P	4510	1

##### For rear terminals

4210 52	For DPX <sup>3</sup> 250 3P	2542	1
4210 53	For DPX <sup>3</sup> 250 4P	2796	1

#### Fixing plates

4210 72	For DPX <sup>3</sup> 250 3P / 4P without earth leakage module	380	1
4210 74	For DPX <sup>3</sup> 250 4P with earth leakage module	1614	1
4210 69	For DPX <sup>3</sup> 250 3P / 4P with side mounting motor operator	942	1

## DPX<sup>3</sup> 630 equipment and accessories

### Plug-in version

4222 20	Set of incoming and outgoing terminals - 3P (6 terminals for 3P DPX <sup>3</sup> or 8 terminals for 4P DPX <sup>3</sup> )	■	1
---------	---	---	---

## DPX<sup>3</sup> 630

### equipment and accessories

Cat.Nos	Description	MRP* ₹ / Unit	Pack
---------	-------------	------------------	------

#### Plug-in version

4222 21	Set of incoming and outgoing terminals - 4P (6 terminals for 3P DPX <sup>3</sup> or 8 terminals for 4P DPX <sup>3</sup> )	■	1
4222 22	Front terminal mounting base for DPX <sup>3</sup> only - 3P	■	1
4222 24	Flat rear terminal mounting base for DPX <sup>3</sup> only - 3P	■	1
4222 23	Front terminal mounting base for DPX <sup>3</sup> only - 4P	■	1
4222 25	Flat rear terminal mounting base for DPX <sup>3</sup> only - 4P	■	1
4222 26	Front terminal mounting base for DPX <sup>3</sup> with earth leakage module - 4 P	■	1
4222 27	Flat rear terminal mounting base for DPX <sup>3</sup> with earth leakage module - 4P	■	1
4222 37	For fixing the signalling contact - 4P Cat.No 0265 74 on a DPX <sup>3</sup> plug-in version	■	1
4222 28	Set of 2 extractor handle	■	1
4222 29	Set of connectors (24-pin)	■	1

#### Draw-out version

4222 31	"Debro-lift" mechanism for DPX <sup>3</sup> base only - 3P	■	1
4222 32	"Debro-lift" mechanism for DPX <sup>3</sup> base only - 4P	■	1
4222 33	"Debro-lift" mechanism for DPX <sup>3</sup> base with elm - 4P	■	1
0265 76	One key for "Debro-lift" mechanism for DPX <sup>3</sup> only - Flat key	■	1
0265 78	Two keys (one key supplied) for "Debro-lift" mechanism for motorised DPX <sup>3</sup> or with rotary handle - Flat key	■	1
0263 48	One key for "Debro-lift" mechanism for DPX <sup>3</sup> only - Star key	■	1
0265 77	Two keys (one key supplied) for motorised DPX <sup>3</sup> or with rotary handle - Star key	■	1
0265 75	Handle for drawing-out for "Debro-lift" mechanism	■	1
0265 74	Signalling contact (plugged-in/drawn-out) for "Debro-lift" mechanism	■	1
4222 36	For fixing the signalling contact Cat.No 0265 74 on a DPX <sup>3</sup> draw-out version	■	1

■ Price available on request.

\* MRP - Maximum Retail Price Inclusive of all taxes including GST.

MCCB Prices are without spreaders. For ordering spreaders refer page no. 21

Bold Cat.Nos are products normally available with Legrand (India) Stockists.

Cat.Nos that are not bold - delivery within 4 - 8 weeks from the date of order.

Bold packing quantity is our mandatory packing. Orders to be placed by Legrand (India) Stockist in multiples of the same.



## DPX<sup>3</sup> 630 equipment and accessories

Cat.Nos	Description	MRP* ₹ / Unit	Pack
---------	-------------	------------------	------

### Draw-out version

4222 30	Block of 6 automatic auxiliary contacts for DPX <sup>3</sup> draw-out version (up to 2 blocks by DPX <sup>3</sup> )	■	1
---------	---	---	---

### Supply inverter type

0264 09	Plate for MCCB or trip-free switch fixed version	9016	1
0264 04	Plate for MCCB or trip-free switch plug-in and draw-out version	14036	1

### Rotary handles

4201 62	Direct rotary handle	1924	1
4201 63	Vari-depth rotary handle	3398	1
4201 70	Key Lock for VD RH DPX <sup>3</sup> 630	2110	1
4201 71	Key Lock for VD RH Type A DPX <sup>3</sup> 630	2110	1
4201 72	Key Lock for VD RH Type B DPX <sup>3</sup> 630	2110	1



0261 40

### Motor-driven handles

0261 40	Front operated 24 V~/=	57647	1
0261 41	Front operated 48 V~/=	57647	1
0261 44	Front operated 230 V~	44294	1
0261 59	Lock and flat key	7110	1
0261 58	Lock and star key	14824	1

### Accessories

0262 30	Set of 3 Insulated shields	186	1
0262 44	Set of 2 sealable terminal shields - 3P	5582	1
0262 45	Set of 2 sealable terminal shields - 4P	1566	1
0262 40	Padlock for locking in "OPEN" position - 4P	1892	1
0262 46	Set of 4 adaptors + insulated shields for lug - 4P	7404	1
0262 47	Set of 4 extended front terminals - 4P	5540	1
6250 04	Set of incoming or outgoing spreaders - 3P	1470	1
6250 08	Set of incoming or outgoing spreaders - 4P	1996	1
0263 50	Set of incoming or outgoing swivel rear terminals - 3P	■	1
0263 52	Set of incoming or outgoing flat rear terminals - 3P	17896	1
0263 51	Set of incoming or outgoing swivel terminals - 4P	■	1
0263 53	Set of incoming or outgoing flat terminals - 4P	■	1
4222 34	Set of 2 IP 20 terminal covers - 3P	■	1
4222 35	Set of 2 IP 20 terminal covers - 4P	■	1



6250 04



4222 34



4222 35

■ Price available on request.

\* MRP - Maximum Retail Price Inclusive of all taxes including GST.

## DPX<sup>3</sup> 630 earth leakage module

Type and frame size	Rated Current (A)	Poles	Cat.Nos	MRP* ₹ / Unit	Pack
---------------------	-------------------	-------	---------	------------------	------

### Earth Leakage Module

#### Standard

DPX <sup>3</sup> 630	400 A	3 Pole	0260 60	32626	1
	630 A	3 Pole	0260 64	60756	1
DPX <sup>3</sup> 630	400 A	4 Pole	0260 61	57266	1
	630 A	4 Pole	0260 65	60360	1

#### LED Version

DPX <sup>3</sup> 630	400 A	4 Pole	0260 63	■	1
	630 A	4 Pole	0260 67	■	1

## DPX<sup>3</sup> 1600 equipment and accessories

Cat.Nos	Description	MRP* ₹ / Unit	Pack
---------	-------------	------------------	------

### Draw-out version

4225 86	Front terminals - 3P	■	1
4225 88	Rear terminals - 3P	■	1
4225 87	Front terminals - 4P	■	1
4225 89	Rear terminals - 4P	■	1
4225 93	Debtor-lift mechanism For DPX <sup>3</sup> 1600 - 3P	■	1
4225 94	Debtor-lift mechanism for DPX <sup>3</sup> 1600 - 4P	■	1
4225 95	For fixing the signalling contact Cat.No 0265 74 on a DPX <sup>3</sup> draw-out version	■	1
0265 76	One key for "Debtor-lift" mechanism for DPX <sup>3</sup> only - Flat key	■	1
0265 80	Two key (one key supplied) for motorised DPX <sup>3</sup> or with rotary handle	■	1
0263 48	One key for DPX <sup>3</sup> only - Starkey	■	1
0265 79	Two key (one key supplied) for motorised DPX <sup>3</sup> or with rotary handle	■	1
0265 75	Handle for drawing-out for "Debtor-lift" mechanism	■	1
0265 74	Signalling contact (plugged-in/drawn-out)	■	1
4222 30	Block of 6 automatic auxiliary contacts for DPX <sup>3</sup> draw-out version (up to 2 blocks by DPX <sup>3</sup> )	■	1



4225 88  
+  
4225 93

Bold Cat.Nos are products normally available with Legrand (India) Stockists. Cat.Nos that are not bold - delivery within 4 - 8 weeks from the date of order. Bold packing quantity is our mandatory packing. Orders to be placed by Legrand (India) Stockist in multiples of the same.



## DPX<sup>3</sup> 1600 equipment and accessories

Cat.Nos	Description	MRP* ₹ / Unit	Pack
---------	-------------	------------------	------

### Supply inverter type

0264 10	Plate for MCCBs or trip-free switch fixed version	10854	1
0264 05	Plate for MCCBs or trip-free switch plug-in and draw-out version	24276	1

### Rotary handles

0262 61	Standard (black) direct on DPX <sup>3</sup>	3748	1
0262 83	Standard (black) vari-depth handle IP 55	5746	1
0262 93	Key barrel and flat key	2134	1
0262 94	Key barrel and star key	11772	1

### Motor-driven handles

0261 54	Front operated 230 V±	75130	1
0261 24	Front operated 24 V±/= for I <sub>n</sub> ≤ 1250 A	109844	1
0261 25	Front operated 48 V±/= for I <sub>n</sub> ≤ 1250 A	94781	1

### Motor-driven handles

0261 26	Front operated 110 V±/= for I <sub>n</sub> ≤ 1250 A	■	1
0261 23	Front operated 230 V±/= for I <sub>n</sub> ≤ 1250 A	52018	1
0261 19	Front operated 24 V±/= for I <sub>n</sub> = 1600 A	109844	1
0261 28	Front operated 48 V±/= for I <sub>n</sub> = 1600 A	94781	1
0261 29	Front operated 110 V±/= for I <sub>n</sub> = 1600 A	■	1
0261 27	Front operated 230 V±/= for I <sub>n</sub> = 1600 A	55514	1
0261 59	Key and flat key	7110	1
0261 58	Key and star key	14824	1

### Accessories

0262 66	Set of 3 insulated shields	364	1
0262 64	Set of 2 sealable terminal shields - 3P	11105	1
0262 65	Set of 2 sealable terminal shields - 4P	2428	1
0262 60	Padlock for locking in "open" position	2086	1
0262 67	Set of 4 extended front short terminals for 630 - 1250 A (2 bars max. per pole)	13481	1



0262 60

- Price available on request.
- \* MRP - Maximum Retail Price Inclusive of all taxes including GST.
- ◆ For Cat.Nos. and further details please contact th nearest branch.
- ▼ For communication add 4226 82 + 4226 89

## DPX<sup>3</sup> 630 and 1600 common auxiliaries

Cat.Nos	Description	MRP* ₹ / Unit	Pack
---------	-------------	------------------	------

### Accessories

0262 68	Set of 4 extended front Long terminals for 1600 A (3 bars max. per pole)	20664	1
4226 24	Set of incoming or outgoing spreaders for 800 A & 1000 A - 3P	■	1
4226 25	Set of incoming or outgoing spreaders for 800 A & 1000 A - 4P	■	1
0262 73	Set of incoming or outgoing spreaders for 1250 A & 1600 A - 3P	■	1
0262 74	Set of incoming or outgoing spreaders for 1250 A & 1600 A - 4P	■	1
0263 80	Short rear terminals - 3P	■	1
0263 81	Long rear terminals - 3P	■	1
0263 82	Short rear terminals - 4P	■	1
0263 83	Long rear terminals - 4P	■	1
4225 90	Set of 2 IP 20 terminal covers - 3P	1528	1
4225 91	Set of 2 IP 20 terminal covers - 4P	2484	1
4225 92	External neutral - 4P	13460	1



0262 67  
+  
0262 68

### Common auxiliaries

4210 11	For signalling the state of the contacts or opening of the MCCB on a fault For DPX <sup>3</sup> /DPX <sup>3</sup> -I Changeover switch 3 A - 240 V±	982	1
---------	--	-----	---

### Releases

Allow remote tripping of a DPX<sup>3</sup>

#### Time-lag undervoltage releases (800 ms)

Prevent false tripping in the event of power supply microbreaks.

Require a time-lag module connected to the undervoltage release Cat.No 4226 23

0261 90	Time-lag module 230 VA 3 module	19946	1
---------	------------------------------------	-------	---

**Bold Cat.Nos** are products normally available with Legrand (India) Stockists. **Cat.Nos that are not bold** - delivery within 4 - 8 weeks from the date of order. **Bold packing quantity** is our mandatory packing. Orders to be placed by Legrand (India) Stockist in multiples of the same.

# DPX<sup>3</sup> MCCB

Rotary handles  
for DPX<sup>3</sup>



- Smaller dimension of rotary handle base for better visibility of parameters and better access to trip unit
- Easy installation
- Spring for better play
- Door defeat mechanism for easy maintenance
- ON / OFF indication on the knob
- Pad Locking on the knob – upto 3 Locks



Scan to know more about  
the product.

Bold Cat.Nos are products normally available with Legrand (India) Stockists. Cat.Nos that are not bold - delivery within 4 - 8 weeks from the date of order. Bold packing quantity is our mandatory packing. Orders to be placed by Legrand (India) Stockist in multiples of the same.

Cat.Nos	Description	MRP* ₹ / Unit	Pack
---------	-------------	------------------	------

### Releases

0261 91	Time-lag module 400 VA	29140	1
4226 23	Undervoltage release for DPX <sup>3</sup> 630 and 1600	■	1

### Auto Transfer Controller

4226 80	Standard unit	28992	1
4226 82	Advanced unit	31628	1
4226 89▼	Communication module	8478	1

### Residual current relay

0260 88	Residual current relay to clip on module 2 rail	20540	1
---------	--	-------	---

### Current Transformer

0260 92	Coil Ø35 mm	■	1
0260 93	Coil Ø80 mm	■	1
0260 94	Coil Ø110 mm	■	1
0260 95	Coil Ø140 mm	■	1
0260 96	Coil Ø210 mm	■	1
0260 97	Coil Ø150 mm - open	■	1
0260 98	Coil Ø300 mm - open	■	1

### DPX<sup>3</sup> ready-to-install ATS kit without MCCBs

6253 80*	Ready to use assembly for DPX <sup>3</sup> 160	244092	1
6253 81*	Ready to use assembly for DPX <sup>3</sup> 160 & DPX <sup>3</sup> 250	246334	1
6253 82*	Ready to use assembly for DPX <sup>3</sup> 250	306796	1
6253 87*	Ready to use assembly for DPX <sup>3</sup> 630	311482	1
6253 93	Kit assembly for ATS for DPX <sup>3</sup> 160	17534	1
6253 94	Kit assembly for ATS for DPX <sup>3</sup> 250	22136	1
6253 95	Kit assembly for ATS for DPX <sup>3</sup> 630	29044	1

### Metal one way enclosures for MCCB

Cat.Nos	Description	No. of modules	MRP* ₹ / Unit	Pack
5078 01	DPX3 160 MCCB enclosure	3&4	3912	1
5078 02	DPX3 250 MCCB enclosure	3&4	6948	1
5078 04	DPX3 630 MCCB enclosure	3&4	10532	1

■ Price available on request.

\* MRP - Maximum Retail Price Inclusive of all taxes including GST.

◆ For Cat.Nos. and further details please contact th nearest branch.

▼ For communication add 4226 82 + 4226 89



4226 82



0260 88



0260 93  
coil for use  
with relay



0260 98



6253 93

# Ekinox <sup>3</sup>™

Smart Solutions

The Core Brick  
of your installation  
is now smarter

## Intelligent EI

Ekinox 3 Smart Distribution Board allows to measure, monitor and control energy from anywhere. Equipped with smart products like EMDX3, CX3 EMS & intelligent accessories. Ekinox 3 helps to evaluate electrical distribution in real time seamlessly.



VTPN MCCB + METER BOARD



Scan to know more about  
the product.





# Ekinox<sup>3</sup>

Smart Solutions

## MIVAN CONSTRUCTION COMPATIBLE EKINOX<sup>3</sup> DB



Mivan Construction Compatible Ekinox<sup>3</sup> distribution boards are made with thick sheets to withstand extreme pressures during the Mivan construction process. The sleek, minimalistic and stylish design enhance the overall ambience of the spaces.

### SALIENT FEATURES

Easily removable knock outs for cable glanding

Full proof solution

Innovative door knob

Integrated door earthing system

Door separately packed

Plain look with rounded corners

Stronger glanding plates

Nut inserts for longer installation life

Increased sheet thickness to withstand Mivan Construction challenges

Slimmest DB with 71 mm depth

IP 43 degree of protection

Wire set, Din rail components, Neutral and Earth bar packed separately in inner assembly set



Scan to know more about the product.

## Ekinox<sup>3</sup> SPN DB's

for DX<sup>3</sup> MCB, Isolator, RCCB and RCBO

Cat.Nos	Number of ways	No. of modules	MRP* ₹ / Unit	Pack
---------	----------------	----------------	------------------	------

- As per IEC 61439-3
- Suitable for Flush Mounting and Surface Mounting
- With 100 A Copper Busbar
- With Neutral bar, Earthbar and Cable ties for Cable management
- Fully shrouded Neutral bars
- Prefitted masking sheet
- Reversible Door for IP 43 & IP 54 DB's

### IP 30 - \*IK 08

5076 00	4 way	4	1410	1
5076 01	8 way	8	1720	1
5076 02	12 way	12	2034	1
5076 03	16 way	16	2484	1
5076 04	18 way	18	2864	1
5076 05	20 way	20	2942	1



5076 05

### IP 43 - \*IK 09 with metal door

5076 10	4 way	4	1876	1
5076 11	8 way	8	2316	1
5076 12	12 way	12	2784	1
5076 13	16 way	16	3532	1
5076 14	18 way	18	3612	1
5076 15	20 way	20	4382	1



5076 12

### IP 43 - \*IK 09 with acrylic door

5076 20	4 way	4	2462	1
5076 21	8 way	8	2852	1
5076 22	12 way	12	3464	1
5076 23	16 way	16	4306	1
5076 24	18 way	18	4590	1
5076 25	20 way	20	4860	1



5076 42

### IP 54 - \*IK 09

5076 40	4 way	4	6408	1
5076 41	8 way	8	7604	1
5076 42	12 way	12	8734	1
5076 43	16 way	16	9718	1
5076 44	18 way	18	9922	1
5076 45	20 way	20	10782	1

## Ekinox<sup>3</sup> ETPN DB's

for DX<sup>3</sup> MCB, Isolator, RCCB and RCBO

- As per IEC 61439-3
- Suitable for Flush Mounting and Surface Mounting
- With 100 A Copper Busbar for each phase
- With Neutral bar, Earthbar and Cable ties for Cable management
- Fully insulated busbar & shrouded Neutral bars
- Improved Pan assembly for ease of installation
- Prefitted masking sheet
- Reversible Door for IP 43 & IP 54 DB's
- With provision for FP MCB/Isolator/RCCB/RCBO as incomer and SP MCB's as outgoing
- Supplied with wireset
- Can be converted to PPI DB at site using conversion kit

### IP 30 - \*IK 08

5076 60	4 way	8+12	3856	1
5076 61	6 way	8+18	4782	1
5076 62	8 way	8+24	5648	1
5076 63	12 way	8+36	8130	1
5076 64	16 way	8+48	10020	1
5076 66	20 way	8+60	13848	1



5077 01



5077 11

## Ekinox<sup>3</sup> ETPN DB's

for DX<sup>3</sup> MCB, Isolator, RCCB and RCBO

Cat.Nos	Number of ways	No. of modules	MRP* ₹ / Unit	Pack
---------	----------------	----------------	------------------	------

### IP 43 - \*IK 09 with metal door

5076 70	4 way	8+12	4584	1
5076 71	6 way	8+18	5708	1
5076 72	8 way	8+24	6846	1
5076 73	12 way	8+36	10254	1
5076 74	16 way	8+48	12712	1
5076 76	20 way	8+60	17796	1

### IP 43 - \*IK 09 with acrylic door

5076 80	4 way	8+12	6134	1
5076 81	6 way	8+18	7430	1
5076 82	8 way	8+24	8828	1
5076 83	12 way	8+36	13542	1
5076 84	16 way	8+48	16184	1
5076 86	20 way	8+60	22522	1

### IP 54 - \*IK 09

5076 90	4 way	8+12	15412	1
5076 91	6 way	8+18	18546	1
5076 92	8 way	8+24	20284	1
5076 93	12 way	8+36	28586	1
5076 94	16 way	8+48	34304	1
5076 96	20 way	8+60	40494	1

## Ekinox<sup>3</sup> Flexy DB

for DX<sup>3</sup> DIN modular products

Cat.Nos	Number of row	No. of modules	MRP* ₹ / Unit	Pack
---------	---------------	----------------	------------------	------

- As per IEC 61439-3
- Suitable for Flush Mounting and Surface Mounting
- Completely flexible to organise the distribution as per site requirements
- Busbars to be selected as per distribution requirements
- With Neutral and Earth bars
- Fully shrouded Neutral bars
- Improved Pan assembly for ease of installation
- Prefitted masking sheet
- Reversible door for IP 43

### IP 30 - \*IK 08

5077 01	2 row of 14 M	28	4840	1
5077 02	3 row of 14 M	42	5978	1
5077 03	4 row of 14 M	56	6718	1

### IP 43 - \*IK 09 with metal door

5077 05	2 row of 14 M	28	5874	1
5077 06	3 row of 4 M	42	7054	1
5077 07	4 row of 14 M	56	7684	1
5077 14	4 row of 8 M	32	6114	1
5077 15	4 row of 10 M	40	6340	1
5077 12	3 row of 14 M MCCB for DPX <sup>3</sup> 160 MCCB	42	7682	1

### IP 43 - \*IK 09 with acrylic door

5077 09	2 row of 14 M	28	6094	1
5077 10	3 row of 14 M	42	7474	1
5077 11	4 row of 14 M	56	8468	1
5077 13	3 row of 14 M MCCB for DPX <sup>3</sup> 160 MCCB	42	8546	1

\* MRP - Maximum Retail Price Inclusive of all taxes including GST.  
#IK - Refer pg - 59 for ready reckoner table.

Bold Cat.Nos are products normally available with Legrand (India) Stockists.  
Cat.Nos that are not bold - delivery within 4 - 8 weeks from the date of order.  
Bold packing quantity is our mandatory packing. Orders to be placed by Legrand (India) Stockist in multiples of the same.



## Ekinox<sup>3</sup> TPN DB-VTPN DB's

for DX<sup>3</sup> MCB, Isolator, RCCB and RCBO

Cat.Nos	Number of ways	No. of modules	MRP* ₹ / Unit	Pack
---------	----------------	----------------	------------------	------

- As per IEC 61439-3
- Suitable for Flush Mounting and Surface Mounting
- With 100 A Copper Busbar for each phase
- With 2 Neutral bar, 2 Earthbar and Cable ties for Cable management
- Fully insulated busbar & shrouded Neutral bars
- Improved Pan assembly for ease of installation
- Prefitted masking sheet
- Reversible Door for IP 43 & IP 54 DB's
- With provision for FP MCB/Isolator/RCCB/RCBO as incomer and SP/TP MCB's as outgoing

### IP 30 - #IK 08

5077 20	4 way	8+12	10550	1
5077 21	6 way	8+18	11602	1
5077 22	8 way	8+24	12880	1
5077 23	12 way	8+36	18598	1

### IP 43 - #IK 09 with metal door

5077 25	4 way	8+12	11392	1
5077 26	6 way	8+18	12616	1
5077 27	8 way	8+24	14656	1
5077 28	12 way	8+36	19910	1

### IP 43 - #IK 09 with acrylic door

5077 30	4 way	8+12	15014	1
5077 31	6 way	8+18	16518	1
5077 32	8 way	8+24	19090	1
5077 33	12 way	8+36	25468	1

### IP 54 - #IK 09

5077 35	4 way	8+12	23784	1
5077 36	6 way	8+18	26166	1
5077 37	8 way	8+24	28608	1
5077 38	12 way	8+36	37396	1

## Ekinox<sup>3</sup> TPN DB-VTPN DPX<sup>3</sup> 160 MCCB DB's

- As per IEC 61439-3
- Suitable for Flush Mounting and Surface Mounting
- With 250 A Copper Busbar for each phase
- With 2 Neutral bar, 2 Earthbar and Cable ties for Cable management
- Fully insulated busbar & shrouded Neutral bars
- Improved Pan assembly for ease of installation
- Prefitted masking sheet
- Reversible Door for IP 43 & IP 54 DB's
- With provision for DPX<sup>3</sup> 160 MCCB as incomer and SP/TP MCB's as outgoing

### IP 30 - #IK 08

5077 40	4 way	DPX <sup>3</sup> 160+12	11930	1
5077 41	6 way	DPX <sup>3</sup> 160+18	12884	1
5077 42	8 way	DPX <sup>3</sup> 160+24	14118	1
5077 43	12 way	DPX <sup>3</sup> 160+36	21344	1

### IP 43 - #IK 09 with metal door

5077 45	4 way	DPX <sup>3</sup> 160+12	13752	1
5077 46	6 way	DPX <sup>3</sup> 160+18	15624	1
5077 47	8 way	DPX <sup>3</sup> 160+24	17196	1
5077 48	12 way	DPX <sup>3</sup> 160+36	23444	1

\* MRP - Maximum Retail Price Inclusive of all taxes including GST.  
#IK - Refer pg - 59 for ready reckoner table.

## Ekinox<sup>3</sup> TPN DB-VTPN DPX<sup>3</sup> 160 MCCB DB's

Cat.Nos	Number of ways	No. of modules	MRP* ₹ / Unit	Pack
---------	----------------	----------------	------------------	------

### IP 54 - #IK 09

5077 50	4 way	DPX <sup>3</sup> 160+12	27912	1
5077 51	6 way	DPX <sup>3</sup> 160+18	31782	1
5077 52	8 way	DPX <sup>3</sup> 160+24	34528	1
5077 53	12 way	DPX <sup>3</sup> 160+36	45486	1

## Ekinox<sup>3</sup> TPN DB-VTPN DPX<sup>3</sup> 250 MCCB DB's

- As per IEC 61439-3
- Suitable for Flush Mounting and Surface Mounting
- With 250 A Copper Busbar for each phase
- With 2 Neutral bar, 2 Earthbar and Cable ties for Cable management
- Fully insulated busbar & shrouded Neutral bars
- Improved Pan assembly for ease of installation
- Prefitted masking sheet
- Reversible Door for IP 43 & IP 54 DB's
- With provision for DPX<sup>3</sup> 250 MCCB as incomer and SP/TP MCB's as outgoing

### IP 30 - #IK 08

5077 55	4 way	DPX <sup>3</sup> 250+12	19514	1
5077 56	8 way	DPX <sup>3</sup> 250+24	20746	1
5077 57	12 way	DPX <sup>3</sup> 250+36	22896	1

### IP 43 - #IK 09 with metal door

5077 58	4 way	DPX <sup>3</sup> 250+12	22204	1
5077 59	8 way	DPX <sup>3</sup> 250+24	25926	1
5077 60	12 way	DPX <sup>3</sup> 250+36	27326	1

### IP 54 - #IK 09

5077 61	4 way	DPX <sup>3</sup> 250+12	33316	1
5077 62	8 way	DPX <sup>3</sup> 250+24	37628	1
5077 63	12 way	DPX <sup>3</sup> 250+36	44058	1

## Ekinox<sup>3</sup> TPN DB-Phase selector DB's for DX<sup>3</sup> MCB, Isolator, RCCB and RCBO

- As per IEC 61439-3
- With inbuilt 3 nos of 63 A Phase selector switches and 3 Nos Piano Switches
- Suitable for Flush Mounting and Surface Mounting
- With 100 A Copper Busbar for each phase
- With Neutral bar, Earthbar and Cable ties for Cable management
- Fully insulated busbar & shrouded Neutral bars
- With provision for FP MCB/Isolator/RCCB/RCBO as incomer and SP MCB's as outgoing
- Supplied with wire set

### IP 30 - #IK 08

5077 70	4 way	8+12	14032	1
5077 71	6 way	8+18	14924	1
5077 72	8 way	8+24	16536	1
5077 73	12 way	8+36	18312	1

### IP 43 - #IK 09 with metal door

5077 80	4 way	8+12	16090	1
5077 81	6 way	8+18	16346	1
5077 82	8 way	8+24	17512	1
5077 83	12 way	8+36	19716	1

Bold Cat.Nos are products normally available with Legrand (India) Stockists.  
Cat.Nos that are not bold - delivery within 4 - 8 weeks from the date of order.  
Bold packing quantity is our mandatory packing. Orders to be placed by Legrand (India) Stockist in multiples of the same.

## Ekinox<sup>3</sup> TPN DB - 7 segment DB's for DX<sup>3</sup> MCB, Isolator, RCCB and RCBO

Cat.Nos	Number of ways	No. of modules	MRP* ₹ / Unit	Pack
---------	----------------	----------------	------------------	------

- As per IEC 61439-3
- Separate compartment for incomer, sub-incomer & outgoing devices
- Suitable for Flush Mounting and Surface Mounting
- With 100 A Copper Busbar for each phase
- With Neutral bar, Earthbar and Cable ties for Cable management
- Fully insulated busbar & shrouded Neutral bars
- With provision for FP MCB/Isolator/RCCB/RCBO as incomer, DP RCCB/RCBO as sub incomer and SP MCB's as outgoing
- Supplied with wire set
- DB with phase segmentation and separation between incomer and outgoing

### IP 30 - \*IK 08

5078 80	4 way	8+12+12	10646	1
5078 81	6 way	8+12+18	11276	1
5078 82	8 way	8+12+24	12254	1
5078 83	12 way	8+12+36	14076	1

### IP 43 - \*IK 09 with metal door

5078 85	4 way	8+12+12	12018	1
5078 86	6 way	8+12+18	13536	1
5078 87	8 way	8+12+24	15114	1
5078 88	12 way	8+12+36	18790	1

## Ekinox<sup>3</sup> TPN DB - 7 segment DB's for 160 A DPX<sup>3</sup> MCCB

- As per IEC 61439-3
- DB with phase segmentation and separation between incomer and Outgoings
- Suitable for Flush Mounting and Surface Mounting
- With 100 A Copper Busbar for each phase
- With Neutral bar, Earthbar and Cable ties for Cable management
- Fully Color Shrouded Insulated bus bar and Neutral bars
- With provision for DPX<sup>3</sup> 160 MCCB as incomer DP MCB/Isolator/RCCB/RCBO as sub incomers and SP MCB's as outgoing
- Supplied with wire set

### IP 30 - \*IK 08

5078 90	4 way	DPX <sup>3</sup>	14918	1
		160+12+12		
5078 91	6 way	DPX <sup>3</sup>	17164	1
		160+12+18		
5078 92	8 way	DPX <sup>3</sup>	19724	1
		160+12+24		
5078 93	12 way	DPX <sup>3</sup>	22900	1
		160+12+36		

\* MRP - Maximum Retail Price Inclusive of all taxes including GST.  
#IK - Refer pg - 59 for ready reckoner table.

## Ekinox<sup>3</sup> TPN DB - 7 segment DB's for 160 A DPX<sup>3</sup> MCCB

Cat.Nos	Number of ways	No. of modules	MRP* ₹ / Unit	Pack
---------	----------------	----------------	------------------	------

### IP 43 - \*IK 09 with metal door

5078 95	4 way	DPX <sup>3</sup>	16508	1
		160+12+12		
5078 96	6 way	DPX <sup>3</sup>	18896	1
		160+12+18		
5078 97	8 way	DPX <sup>3</sup>	21848	1
		160+12+24		
5078 98	12 way	DPX <sup>3</sup>	24642	1
		160+12+36		

## Ekinox<sup>3</sup> Metra plug & socket DB's for DX<sup>3</sup> MCB, RCCB and RCBO

Cat.Nos	Description	No. of modules	MRP* ₹ / Unit	Pack
---------	-------------	----------------	------------------	------

- As per IEC 61439-3
- Suitable for Flush Mounting and Surface Mounting
- Suitable for protection of appliances like AC/Geyser etc
- Supplied with Neutral Links
- With provision for mounting modular devices

### \*IK 08

5078 10	10 A SP, 2P+E	1	1828	1
5078 11	20 A SP, 2P+E	1	1970	1
5078 14	20 A DP, 2P+E	2	2140	1
5078 17	20 A TP, 3P+E	3	3626	1
5078 18	32 A TP, 3P+E	3	4302	1
5078 20	20 A DP RCBO, 2P+E	4	2070	1
5078 21	20 A FP RCBO, 2P+E	8	3620	1
5078 22	32 A FP RCBO, 3P+E	8	4270	1

## Ekinox<sup>3</sup> P-17 Tempra plug & socket DB's for DX<sup>3</sup> MCB, RCCB and RCBO

- As per IEC 61439-3
- Suitable for Flush Mounting and Surface Mounting
- Supplied with Neutral Links
- With provision for mounting modular devices

### \*IK 08

5078 60	16 A 2P+E-DP	2	2988	1
5078 63	32 A 2P+E-DP	2	3226	1
5078 61	32 A 3P+E-FP	8	5406	1
5078 62	32 A 3P+N+E-FP	8	5468	1
5078 64	63 A 3P+N+E-FP	8	13608	1

Bold Cat.Nos are products normally available with Legrand (India) Stockists.  
Cat.Nos that are not bold - delivery within 4 - 8 weeks from the date of order.  
Bold packing quantity is our mandatory packing. Orders to be placed by Legrand (India) Stockist in multiples of the same.



5078 95



5078 86



5078 14



5078 22



5078 60



5078 62



5078 64



## Ekinox<sup>3</sup> Metal enclosures

for DX<sup>3</sup> MCB, RCCB, RCBO and DPX<sup>3</sup> MCCB's

Cat.Nos	Description	No. of modules	MRP* ₹ / Unit	Pack
---------	-------------	----------------	---------------	------

- As per IEC 61439-3
- For independent mounting of DX<sup>3</sup> MCB, RCCB, RCBO, DPX<sup>3</sup> 160, DPX<sup>3</sup> 250, DPX<sup>3</sup> 630 & DRX MCCB's
- #IK 08

### #IK 08

5077 90	SP enclosure	1	498	1
5077 91	DP enclosure	2	726	1
5077 92	TP enclosure	3	726	1
5077 93	FP enclosure	4	726	1
5077 94	FP RCBO enclosure	8	1224	1

### Metal one way enclosures for MCCB

5078 01	DPX <sup>3</sup> 160 MCCB enclosure	3&4	4080	1
5078 02	DPX <sup>3</sup> 250 MCCB enclosure	3&4	7246	1
5078 04	DPX <sup>3</sup> 630 MCCB enclosure	3&4	10984	1
5078 05	DRX 100 MCCB enclosure-TP	3	2180	1
5078 06	DRX 100 MCCB enclosure-FP	4	2056	1

### Ekinox<sup>3</sup> cable end box

Cat.Nos	Description	MRP* ₹ / Unit	Pack
---------	-------------	---------------	------

- Useful for keeping extra cables
- Possible to mount on the top or bottom of the DB
- Provision for mounting terminal blocks
- Can be used as a terminal box adaptor also

### For IP 30 DB's

5079 10	For SPN 4 W IP30	714	1
5079 12	For SPN 8 W IP30	822	1
5079 14	For SPN 12 W/ VTPN/Flexy	900	1
5079 16	For SPN 16 W/ ETPN 6 way DB	1258	1
5079 25	For ETPN 8 way DB	2270	1
5079 27	For ETPN 12 way DB	2996	1
5079 29	For ETPN 16 way DB	3026	1
5079 31	For ETPN 18 way DB	3308	1
5079 33	For ETPN 20 way DB	3328	1
5079 35	For ETPN 4 way VTPN/FLEXY MCB	900	1
5079 37	For all VTPN MCCB DBS	3344	1

### For IP 43 DB's

5079 11	For SPN 4 way DB	798	1
5079 13	For SPN 8 way DB	956	1
5079 15	For SPN 12 way/ VTPN/Flexy DB	1072	1

\* MRP - Maximum Retail Price Inclusive of all taxes including GST.  
#IK - Refer pg - 59 for ready reckoner table.

## Ekinox<sup>3</sup> cable end box

Cat.Nos	Description	MRP* ₹ / Unit	Pack
---------	-------------	---------------	------

### For IP 43 DB's

5079 17	For SPN 16 way/ ETPN 6 way DB	1520	1
5079 18	For SPN 18 way DB	1552	1
5079 19	For SPN 20/ETPN 8 way DB	1590	1
5079 28	For ETPN 12 way DB	3444	1
5079 30	For ETPN 16 way DB	3476	1
5079 32	For ETPN 18 way DB	3798	1
5079 34	For ETPN 20 way DB	3822	1
5079 36	For all ETPN 4W/VTPN/Flexy MCB	1072	1
5079 38	For all VTPN MCCB DBs	3838	1
5079 00	For 7 segment 4 way DB	3540	1
5079 01	For 7 segment 6 way DB	3882	1
5079 02	For 7 segment 8 way DB	4332	1
5079 03	For 7 segment 12 way DB	4894	1

## Ekinox<sup>3</sup> DBs

### meter box

- Suitable for Mounting DX<sup>3</sup> Metering products
- Possible to mount on the top or bottom of the DB
- Provision for mounting Ammeter/Voltmeter/ASS/VSS
- #IK09

### Provision for mounting meters

5079 40	For VTPN MCB INCOM IP 30	4510	1
5079 41	For VTPN MCB INCOM IP 43	5416	1
5079 42	For VTPN MCCB INCOM IP 30	5014	1
5079 43	For VTPN MCCB INCOM IP 43	6190	1

### Per phase Isolation kit

5079 44	PPI conversion kit for ETPN 4 way DB	2640	1
5079 45	PPI conversion kit for ETPN 6 way DB	2976	1
5079 46	PPI conversion kit for ETPN 8 way DB	3442	1
5079 47	PPI conversion kit for ETPN 12 way DB	3838	1
5079 48	PPI conversion kit for ETPN 16 way DB	4310	1

### Panel locks

5079 52	Panel knob for IP 43	296	1
5079 51	Panel knob with key	606	1

**Bold Cat.Nos** are products normally available with Legrand (India) Stockists. **Cat.Nos that are not bold** - delivery within 4 - 8 weeks from the date of order. **Bold packing quantity** is our mandatory packing. Orders to be placed by Legrand (India) Stockist in multiples of the same.



## Ekinox™ distribution boards

Cat.Nos	Number of ways	MRP* ₹ / Unit	Pack
---------	----------------	---------------	------

### Plexo3 boxes for DX<sup>3</sup>

Self-extinguishing: resistance to incandescent wire 650 °C

Conform to EN 60439-3

Weatherproof cabinets - IP 65 - IK 09 - Class II

Door and cabinet fully reversible

Removable chassis and faceplates from 2-row versions up

2-position rail for modular products and moulded cases

Spacing between rails 150 mm

Box colour light grey L750A, cover colour dark grey R746A



6019 94

6019 32	2 (+1) Module	1754	1
6019 94	4 Module	1870	1
6019 96	6 Module	2142	1
6019 98	8 Module	2678	1



6018 32

### Cabinets with 12 modules per row

6018 31	1 row 12 modules	4218	1
6018 32	2 rows 24 modules	5850	1
6018 33	3 rows 36 modules	8154	1

### Cabinets with 18 modules per row

6018 35	18 modules x 1 row	5202	1
6018 36	18 modules x 2 rows	8998	1
6018 37	18 modules x 3 rows	12654	1
6018 38	18 modules x 4 rows	19690	1



6018 32 +  
0019 17

### Multifunction sleeves for P17

0019 17	For 2 row cabinets	3410	1
0019 18	For 3 row cabinets	5112	1
0019 67	Joining kit	996	1

**Ekinox**   
Smart Solutions

## Metra Plug & Socket DB's

The Right Choice for all your application needs



Note: For Plexo3 Box with integrated Neutral & Earth Bars contact nearest Sales Office

\* MRP - Maximum Retail Price Inclusive of all taxes including GST.

Refer instruction manual for MIVAN (Aluminum shuttering) compatible DB's

## Distribution boards

Cat.Nos	No. of devices connected	No. of 17.5 mm modules	MRP* ₹ / Unit	Pack
---------	--------------------------	------------------------	---------------	------

### Supply busbars - insulated

63 A copper

#### Pin type

##### SP I/C & SP O/G

4049 26	13	13	346	1
4049 37	57	57	1344	1

##### SPN I/C & SPN O/G

4049 38	6	12	610	1
4049 39	28	56	2514	1

##### TPN I/C & SPN O/G

4049 40	5	12	626	3/30
4049 41	27	56	6140	5/10

##### TP I/C & TP O/G

4049 42	4	12	630	1
4049 43	19	57	6172	1

##### FP I/C & FP O/G

4049 44	3	12	1514	3/30
4049 45	14	56	6140	5/10

#### Fork type

##### SP I/C & SP O/G

4049 11	13	12	346	1
4049 12	57	57	1316	1

##### SPN I/C & SPN O/G250

4049 14	28	56	2514	1
---------	----	----	------	---

##### TP I/C & TP O/G

4049 17	4	12	626	1
4049 18	19	57	6140	1

##### FP I/C & FP O/G

4049 20	14	56	6140	5/10
---------	----	----	------	------

Cat.Nos	Description	MRP* ₹ / Unit	Pack
---------	-------------	---------------	------

### Accessories for fork and pin type busbars

4049 89	End caps for SP	8	6
4049 90	End caps for DP & TP	40	6
4049 91	End caps for FP	76	20/840

Cat.Nos	Number of ways	MRP* ₹ / Unit	Pack
---------	----------------	---------------	------

### Blanking plates

6014 70	-	14	10
---------	---	----	----

Bold Cat.Nos are products normally available with Legrand (India) Stockists. Cat.Nos that are not bold - delivery within 4 - 8 weeks from the date of order. Bold packing quantity is our mandatory packing. Orders to be placed by Legrand (India) Stockist in multiples of the same.

## Ekinox<sup>3</sup>

For converting ETPN DB to PPI DB

### PPI DB IP 30 - IK 08

No. of ways	Combine		No. of modules
	ETPN DB	PPI Kit	
4 way	4 way 507660	4 way kit 507944	8+12
6 way	6 way 507661	6 way kit 507945	8+18
8 way	8 way 507662	8 way kit 507946	8+24
12 way	12 way 507663	12 way kit 507947	8+36
16 way	16 way 507664	16 way kit 507948	8+48

### PPI DB IP 43 - IK 09 with metal door

No. of ways	Combine		No. of modules
	ETPN DB	PPI Kit	
4 way	4 way 507670	4 way kit 507944	8+12
6 way	6 way 507671	6 way kit 507945	8+18
8 way	8 way 507672	8 way kit 507946	8+24
12 way	12 way 507673	12 way kit 507947	8+36
16 way	16 way 507674	16 way kit 507948	8+48

### PPI DB IP 43 - IK 09 with acrylic door

No. of ways	Combine		No. of modules
	ETPN DB	PPI Kit	
4 way	4 way 507680	4 way kit 507944	8+12
6 way	6 way 507681	6 way kit 507945	8+18
8 way	8 way 507682	8 way kit 507946	8+24
12 way	12 way 507683	12 way kit 507947	8+36
16 way	16 way 507684	16 way kit 507948	8+48

### PPI DB IP 54 - IK 09

No. of ways	Combine		No. of modules
	ETPN DB	PPI Kit	
4 way	4 way 507690	4 way kit 507944	8+12
6 way	6 way 507691	6 way kit 507945	8+18
8 way	8 way 507692	8 way kit 507946	8+24
12 way	12 way 507693	12 way kit 507947	8+36
16 way	16 way 507694	16 way kit 507948	8+48

## IK

Protection against mechanical impact: protection index - IK

According to standard:

IEC 62262, BS EN 62262 and NF EN 62262

• This table can be used to ascertain the resistance of a product to an impact given in Joules from the IK code (graduated from 00 to 10)

It can also be used to ascertain the correspondence with the old IP code 3rd digit and the corresponding external "Ag" conditions

IK	Tests	Impact energy (in Joules)	"AG" of NF C 15-100
IK 00		0	
IK 01		0.15	
IK 02		0.2	AG1
IK 03		0.35	
IK 04		0.5	
IK 05		0.7	
IK 06		1	
IK 07		2	AG2
IK 08		5	AG3
IK 09		10	
IK 10		20	AG4

## IPXX

### Index of protection

IP\*\*\* index of protection of enclosures of electrical equipment in accordance with standards IEC 529, BS 5490, DIN 400 50 and NF C 20-010  
Up to 1000 V± and 1500 V= (standard UTE C 20 010)

#### 1st figure:- protection against solid bodies

IP	tests	
0		No protection
1		Protected against solid bodies larger than 50 mm (eg.: accidental contact with the hand)
2		Protected against solid bodies larger than 12 mm (eg.: finger)
3		Protected against solid bodies larger than 2.5 mm (eg.: tools, wires)
4		Protected against solid bodies larger than 1 mm (eg.: fine tools and small wires)
5		Protected against dust (no harmful deposit)
6		Completely protected against dust

#### 2nd figure:- protection against liquids

IP	tests	
0		No protection
1		Protected against vertically-falling drops of water (condensation)
2		Protected against drops of water falling at up to 15° from the vertical
3		Protected against drops of rain water at up to 60° from the vertical
4		Protected against projections of water from all directions
5		Protected against jets of water from all directions
6		Protected against jets of water of similar force to heavy seas
7		Protected against the effects of immersion
8		Protected against prolonged effects of immersion under pressure

The contents of all the above charts are for guidance only, if you have any doubt as to the interpretation of the information contained therein, please refer either to the standard itself or contact Legrand.

In accordance with our policy of continuous improvement, Legrand reserves the right to change specifications and designs without notice. All information given here is correct at the time of going to press.



# P17 TEMPRA PRO

ALWAYS ENSURING  
CONTINUITY OF SERVICE

By updating its IP44 and IP 66/67 range of industrial sockets, Legrand is meeting the expectations of professional users. New benefits in terms of safety, implementation, design & ergonomics guarantee the longevity of this family of products, which has already proven itself over time.



## IP44

SOCKETS FOR INTERNAL AND EXTERNAL USE, PROTECTED AGAINST PROJECTIONS OF WATER (BUT NOT EXPOSED TO DIRECT JETS)



Straight plugs



Mobile sockets



Panel mounting sockets

A TRANSFORMED RANGE  
WHICH HARMONISES WITH  
THE LEGRAND INDUSTRIAL  
SOCKETS RANGE

- From 16 to 32 A
- 2 P+ E / 3 P+E / 3 P+N+E
- From 100 to 500 VA
- 50/60 Hz
- Screw connection



Scan to know more about  
the product.





AIRPORTS, DATA CENTRES,  
HOTELS, ETC. P17 TEMPRA  
PRO IS IDEAL FOR ALL MAJOR  
PROJECTS

# IP66/67/69\*

WEATHERPROOF SOCKETS THAT  
CAN WITHSTAND TEMPORARY  
IMMERSION (RAIN, FLOODS, ETC)



Surface mounting  
sockets



Straight plugs



Mobile sockets



Panel mounting  
sockets



Surface mounting  
sockets

- From 16 to 125 A
- 2 P+ E / 3 P+E / 3 P+N+E
- From 100 to 500 VA
- 50/60 Hz
- Screw connection

\* On 63 and 125 A plugs and mobile sockets

# P17 TEMPRA PRO

## ENSURING EASE OF USE AND SAFETY

The new P17 Tempra Pro range has been subject to extensive research in terms of design and safety in order to make life safer and easier for the user. Good product gripping, compact dimensions for use in tight spaces, easier handling, etc. Compliance with standards, anti-corrosion treated materials and components, etc. A comprehensive set of solutions which comply with the standards.

AN INNOVATIVE DESIGN THAT COMPLIES WITH STANDARDS IEC 60309-1 AND 2 AND RESPECTS THE ENVIRONMENT

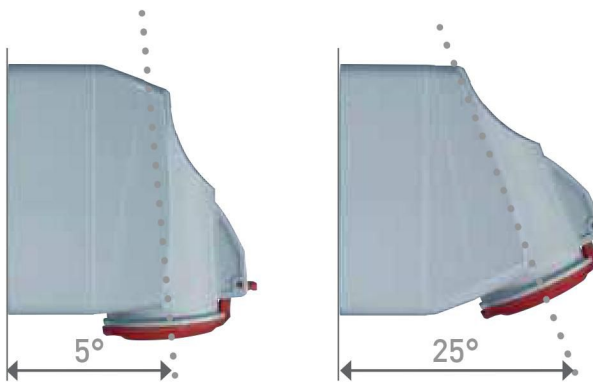

**1 2 MOUNTING POSITIONS\***

To solve the problem of limited space, the surface mounting sockets offer 2 different mounting positions (5° or 25°) which allow users to adapt to the space available without changing the box.



**2 CABLE GRIP**

Captive cable grip with anti-vibration system holds the cable in place permanently. The 63 and 125 A products are also equipped with a locking screw.



**3 EASE OF HANDLING**

Gripping areas on the body of the mobile products and the cable grip.



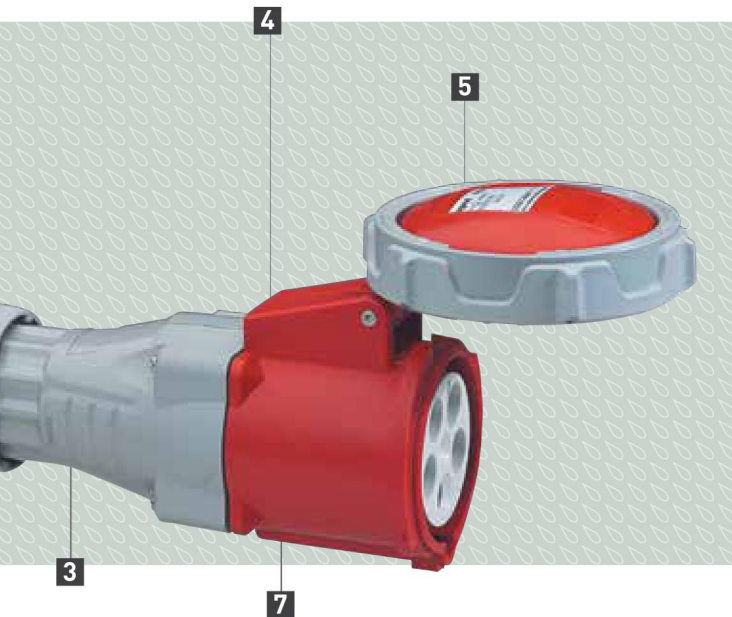

## SAFETY & THE ENVIRONMENT

### SAFETY

Connection terminals compliant with standards IEC 60 309 1 & 2

Production sites certified according to ISO 14001 and ISO 9001

Very high resistance to chemical products. Plugs and sockets made of polyamide 6

Anti-corrosion treated screws, stainless steel springs for the socket covers

Resistant to temperatures of -25°C to +40°C

### ENVIRONMENT

Halogen-free recyclable materials (silicone, PVC) for IP 44 products

Grouped packaging in boxes

PEP products (Eco Passport)

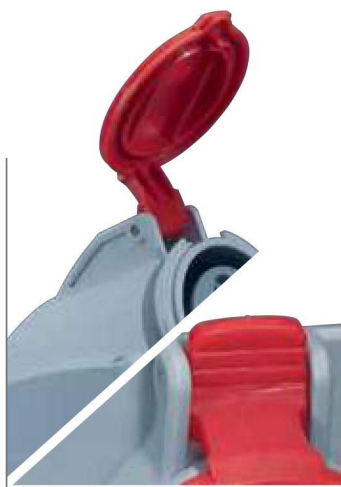

#### 4 OPENING LEVER

For easier connection / disconnection. Cover held open on panel sockets and surface mounting sockets.



#### 5 POSITION MARKING

Information engraved on the ring cover of IP66/67 products means the user can check quickly whether it is in the open or closed position. Marking on cover and flap for easy identification.



#### 6 RIVETED METAL SHAFT

For 63 and 125 A products the riveted metal shaft ensures more strength. The notched locking ring facilitates the locking / unlocking operations.



#### 7 WEATHERPROOF SEALING

For panel mounting sockets.



## P17 Tempra Pro IP 44 - LV 16 and 32 A - sockets and plugs

Cat.Nos	Description	MRP* ₹ / Unit	Pack
---------	-------------	------------------	------

### Surface mounting sockets

5551 54	200/250 V~, 16 A 2P+E	650	10
5551 58	380/415 V~, 16 A 3P+E	804	10
5551 59	380/415 V~, 16 A 3P+N+E	850	10
5552 54	200/250 V~, 32 A 2P+E	816	5
5552 58	380/415 V~, 32 A 3P+E	1018	10
5552 59	380/415 V~, 32 A 3P+N+E	1080	10

### Panel mounting sockets inclined outlet

5551 84	200/250 V~, 16 A 2P+E	404	10
5551 88	380/415 V~, 16 A 3P+E	594	10
5551 89	380/415 V~, 16 A 3P+N+E	626	10
5552 84	200/250 V~, 32 A 2P+E	620	10
5552 88	380/415 V~, 32 A 3P+E	786	10
5552 89	380/415 V~, 32 A 3P+N+E	834	10

### Mobile sockets

5551 04	200/250 V~, 16 A 2P+E	526	10
5551 08	380/415 V~, 16 A 3P+E	586	10
5551 09	380/415 V~, 16 A 3P+N+E	620	10
5552 14	200/250 V~, 32 A 2P+E	696	10
5552 18	380/415 V~, 32 A 3P+E	838	10
5552 19	380/415 V~, 32 A 3P+N+E	886	10

### Straight plugs

5551 24	200/250 V~, 16 A 2P+E	372	10
5551 28	380/415 V~, 16 A 3P+E	456	10
5551 29	380/415 V~, 16 A 3P+N+E	482	10
5552 34	200/250 V~, 32 A 2P+E	562	10
5552 38	380/415 V~, 32 A 3P+E	642	10
5552 39	380/415 V~, 32 A 3P+N+E	682	10

## P17 Tempra - domestic pin configuration 16 A - 250 VA

### Flush-mounting boxes

0577 21	For 2 panel mounting sockets With single fixing centres 70 x 70 mm - 16 A	3724	3
0577 22	For 1 panel mounting socket With single fixing centres 70 x 70 mm - 16 or 32 A (32 A to be fixed horizontally)	2234	3

\* MRP - Maximum Retail Price Inclusive of all taxes including GST.

## P17 Tempra Pro IP 66/67 LV 16 and 32 A

Cat.Nos	Polarity	MRP* ₹ / Unit	Pack
---------	----------	------------------	------

### Surface mounting sockets

5553 54	200/250 V~, 16 A 2P+E	1090	5
5553 58	380/415 V~, 16 A 3P+E	1214	5
5553 59	380/415 V~, 16 A 3P+N+E	1318	5
5554 54	200/250 V~, 32 A 2P+E	1292	5
5554 55	200/250 V~, 32 A 3P+E	2230	5
5554 59	380/415 V~, 32 A 3P+N+E	2418	5

### Panel mounting sockets

5553 84	200/250 V~, 16 A 2P+E	796	5
5553 88	380/415 V~, 16 A 3P+E	848	5
5553 89	380/415 V~, 16 A 3P+N+E	900	5
5554 84	200/250 V~, 32 A 2P+E	1014	5
5554 88	380/415 V~, 32 A 3P+E	1160	5
5554 89	380/415 V~, 32 A 3P+N+E	1230	5

### Mobile sockets

5553 04	200/250 V~, 16 A 2P+E	976	5
5553 08	380/415 V~, 16 A 3P+E	1214	5
5553 09	380/415 V~, 16 A 3P+N+E	1286	5
5554 14	200/250 V~, 32 A 2P+E	1340	5
5554 18	380/415 V~, 32 A 3P+E	1430	5
5554 19	380/415 V~, 32 A 3P+N+E	1520	5

### Straight plugs

5553 24	200/250 V~, 16 A 2P+E	848	5
5553 28	380/415 V~, 16 A 3P+E	930	5
5553 29	380/415 V~, 16 A 3P+N+E	988	5
5554 34	200/250 V~, 32 A 2P+E	1148	5
5554 38	380/415 V~, 32 A 3P+E	1208	5
5554 39	380/415 V~, 32 A 3P+N+E	1280	5

## P17 Tempra Pro IP 66/67 LV 32 A for refrigerated containers

### Combined unit, plug and mobile socket for refrigerated containers

6571 06	Combined unit with interlocked switched socket - Double mechanical interlock - Cable glands are not supplied	17216	1
---------	--	-------	---

Bold Cat.Nos are products normally available with Legrand (India) Stockists. Cat.Nos that are not bold - delivery within 4 - 8 weeks from the date of order. Bold packing quantity is our mandatory packing. Orders to be placed by Legrand (India) Stockist in multiples of the same.

## P17 Tempra Pro IP 66/67 LV 32 A for refrigerated containers

Cat.Nos	Polarity	MRP* ₹ / Unit	Pack
---------	----------	------------------	------

### Combined unit, plug and mobile socket for refrigerated containers

5554 91	Panel mounting socket	1328	5
5554 21	Mobile socket with cable grip Ø12 to 21.5 mm	1610	5
5554 41	Straight plug With cable grip Ø12 to 21.5 mm	1386	5

## P17 Tempra Pro IP 66/67 - LV 63 and 125 A

### Surface mounting sockets

5555 54	200/250 V~, 63 A 2P+E	4508	2
5555 58	380/415 V~, 63 A 3P+E	4710	2
5555 59	380/415 V~, 63 A 3P+N+E	4976	2
5556 58	380/415 V~, 125 A 3P+E	13056	2
5556 59	380/415 V~, 125 A 3P+N+E	13840	2

### Panel mounting sockets

5555 84	200/250 V~, 63 A 2P+E	3574	2
5555 88	380/415 V~, 63 A 3P+E	3646	2
5555 89	380/415 V~, 63 A 3P+N+E	3840	2
5556 88	380/415 V~, 125 A 3P+E	10318	1
5556 89	380/415 V~, 125 A 3P+N+E	11032	1

### Straight plugs

5555 24	200/250 V~, 63 A 2P+E	3028	2
5555 28	380/415 V~, 63 A 3P+E	3074	2
5555 29	380/415 V~, 63 A 3P+N+E	3370	2
5556 28	380/415 V~, 125 A 3P+E	9152	1
5556 29	380/415 V~, 125 A 3P+N+E	9702	1

### Mobile sockets

5555 04	200/250 V~, 63 A 2P+E	3862	2
5555 08	380/415 V~, 63 A 3P+E	4012	2
5555 09	380/415 V~, 63 A 3P+N+E	4258	2
5556 08	380/415 V~, 125 A 3P+E	13322	1
5556 09	380/415 V~, 125 A 3P+N+E	14122	1

## Plugs and sockets

Cat.Nos	Polarity	MRP* ₹ / Unit	Pack
---------	----------	------------------	------

### P17 combined unit to be equipped Bases with mechanical super-compact sockets

0573 00	16 A, 2P+E IP 44 Interlock	4550	1
0573 02	16 A, 3P+N+E IP 44 Interlock	5022	1
0573 20	16 A, 2P+E IP 55 Interlock	5106	1
0573 22	16 A, 3P+N+E IP 55 Interlock	5746	1
0577 23	Mounting plate for 2 super-compact mechanical interlock sockets	2554	1

### Bases for 125 x 220 mm face plates

#### Example of combined unit configuration

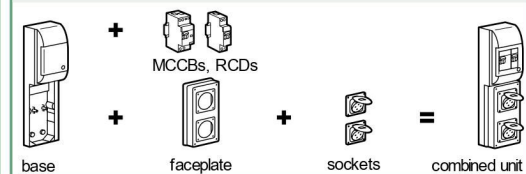

0577 10	Surface mounting box - upto 2 sockets	1066	2
0589 38	Surface mounting box with 5 module dinrail - upto 2 sockets	2976	1
0577 05	Surface mounting box with 12 module dinrail - upto 4 sockets	6572	1
0577 06	Surface mounting box with 18 module dinrail - upto 6 sockets	9198	1

### Face plates 125 x 220 mm without sockets

0577 12	For 1 x 16 A or 32 - upto A socket	1010	5
0577 13	For 2 x 16 A - upto sockets	1268	5
0577 17	For 1 x 63 A - upto sockets	1164	5
0577 15	Blanking Plate	856	5

### Bases for 125 x 280 mm faceplates

0577 11	Surface mounting box - upto 3 sockets	1108	3
0577 20	Surface mounting box with 5 module dinrail - upto 3 sockets	3190	1
0577 03	Surface mounting box with 12 module dinrail - upto 6 sockets	6812	1
0577 04	Surface mounting box with 18 module dinrail - upto 9 sockets	9476	1

\* MRP - Maximum Retail Price Inclusive of all taxes including GST.

**Bold Cat.Nos** are products normally available with Legrand (India) Stockists. **Cat.Nos** that are not bold - delivery within 4 - 8 weeks from the date of order. **Bold packing quantity** is our mandatory packing. Orders to be placed by Legrand (India) Stockist in multiples of the same.



## Plugs and sockets

Cat.Nos	Polarity	MRP* ₹ / Unit	Pack
---------	----------	------------------	------

### Face plates 125 x 280 mm without sockets

0577 18	For 2 x 16 A and / or 32 A sockets	1584	4
0577 19	For 1 x 16 A or 32 A socket and 1 x 63 A socket	1490	2
0577 14	For 3 x 16 A sockets	1806	4
0577 16	Blanking plate	1006	4

## Hypra industrial plugs and sockets

### Sockets

#### Prisinter panel mounting sockets - IP 44, IK 09

0520 02	230 V, 16 A, 2P+E	9868	1/10
0527 02	230 V, 32 A, 2P+E	10658	1/6
0529 03	415 V, 32 A, 3P+E	10924	1/6
0529 04	415 V, 32 A, 3P+N+E	12980	1/6
0536 04	415 V, 63 A, 3P+N+E	41594	1

#### Panel mounting sockets - inclined IP 44, IK 09

0522 23	415 V, 16 A, 3P+E	1588	5/50
0538 23	415 V, 63 A, 3P+E	4964	1

#### Mobile sockets - IP 44, IK 09

0522 83	415 V, 16 A, 3P+E	3802	5/50
---------	-------------------	------	------

### Plugs

#### Straight plugs - IP 44, IK 09

0520 42	250 V, 16 A, 2P+E	1628	5/50
0527 42	250 V, 32 A, 2P+E	2140	1/5
0522 43	415 V, 16 A, 3P+E	2826	5/50
0529 43	415 V, 32 A, 3P+E	2686	5/50
0529 44	415 V, 32 A, 3P+N+E	2976	5/15
0538 43	415 V, 63 A, 3P+E	7102	1/5
0538 44	415 V, 63 A, 3P+N+E	9542	1/5

## Metra plugs and sockets

### Plugs

#### Ivory

6500 22	240 V, 10 A, 2P+E	180	1/5/100
6500 28	240 V, 20 A, 2P+E	190	1/5/100

#### Grey

6500 02	240 V, 10 A, 2P+E	180	1/5/100
6500 08	240 V, 20 A, 2P+E	190	1/5/100
6500 10	440 V, 20 A, 3P+E	254	1/5/100
6500 16	440 V, 32 A, 3P+E	474	1/5/100

### Sockets

6500 03	240 V, 10 A, 2P+E With blue cap	184	1/5/100
6500 23	240 V, 10 A, 2P+E With ivory cap	184	1/5/100

\* MRP - Maximum Retail Price Inclusive of all taxes including GST.

## Hypra industrial plugs and sockets

Cat.Nos	Description	MRP* ₹ / Unit	Pack
---------	-------------	------------------	------

### Sockets

6500 09	240 V, 20 A, 2P+E With blue cap	210	1/5/100
6500 29	240 V, 20 A, 2P+E With ivory cap	210	1/5/100
6500 11	440 V, 20 A, 3P+E With red cap	282	1/5/100
6500 17	440 V, 32 A, 3P+E With red cap	474	1/5/100

## Plugs and sockets

### P17 tempra combined units

#### With interlocked switched sockets and surface mounting box IP 44

0566 01	250 V, 16 A, 2P+E	6834	1
0566 09	250 V, 32 A, 2P+E	8154	1
0566 13	415 V, 32 A, 3P+E	9862	1
0566 14	415 V, 32 A, 3P+N+E	10352	1

#### With interlocked switched sockets and surface mounting box IP 55

0566 21	250 V, 16A, 2P+E	7592	1
0566 29	250 V, 32 A, 2P+E	8674	1
0566 33	415 V, 32 A, 3P+E	10996	1
0566 34	415 V, 32 A, 3P+N+E	11196	1

#### With interlocked switched sockets and surface mounting box IP 44 with DIN rail for 5 module DX<sup>3</sup> protection

0566 41	250 V, 16A, 2P+E	7290	1
0566 49	250 V, 32 A, 2P+E	8868	1
0566 53	415 V, 32 A, 3P+E	9808	1
0566 54	415 V, 32 A, 3P+N+E	10494	1

#### With interlocked switched sockets and surface mounting box IP 66 with DIN rail for 5 module DX<sup>3</sup> protection

0566 61	250 V, 16 A, 2P+E	8168	1
0566 69	250 V, 32 A, 2P+E	9478	1
0566 73	415 V, 32 A, 3P+E	10232	1
0566 74	415 V, 32 A, 3P+N+E	11060	1

#### With interlocked switched sockets and without surface mounting box IP 55

0572 21	250 V, 16 A, 2P+E	6572	1
0572 29	250 V, 32 A, 2P+E	7430	1
0572 33	415 V, 32 A, 3P+E	8822	1
0572 34	415 V, 32 A, 3P+N+E	9636	1
0572 95	415 V, 63 A, 3P+N+E, IP 66	21030	1
0577 00	Base box for 0572 95	3752	1

### P17 tempra combined units

#### with interlocked switched sockets IP 66

0589 18	380 to 415 V, 50/60 Hz, 63 A, 3P + E with provision for 5 module DX <sup>3</sup> protection	22396	1
0572 99	380 to 415 V, 50/60 Hz, 63 A, 3P+N+E with provision for 5 module DX <sup>3</sup> protection	25238	1

Bold Cat.Nos are products normally available with Legrand (India) Stockists. Cat.Nos that are not bold - delivery within 4 - 8 weeks from the date of order. Bold packing quantity is our mandatory packing. Orders to be placed by Legrand (India) Stockist in multiples of the same.



# ARTEOR™

VERSATILITY AND A  
GLOBAL VISION FOR ANY  
INSTALLATION LEVEL

Arteor™ is the innovative answer to the increasingly complex requirements in the building business all over the world. Arteor™ excels by its unique aesthetics and a rich choice of innovative designs and ergonomical options. The range extends from wiring devices, through innovative IoT based solutions, up to fully networked home automation systems based on BUS technology, which can also be integrated into third party solutions.



Scan to know more about  
the product.

# ARTEOR™

DESIGN FOR A GLOBAL LIFESTYLE

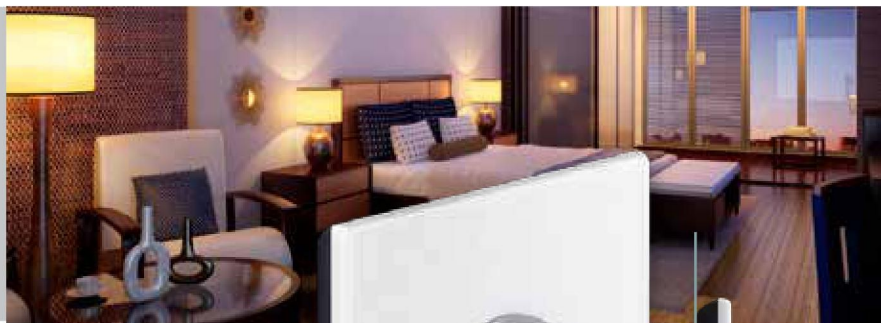

## DESIGN OPTIONS FOR CONTROL FUNCTIONS

Arteor™ offers a wide choice of ergonomics and finishes to satisfy the most demanding customers. All stand-alone control functions are available in two shapes of rockers – round or square – and in three colours – white, magnesium and champagne.



Round rocker  
White



Round rocker  
Magnesium



Round rocker  
Champagne



Square rocker  
White



Square rocker  
Magnesium



Square rocker  
Champagne



# ARTEOR™

HOME

THE IDEAL SOLUTION,  
ALWAYS AND  
EVERYWHERE

Its versatility makes Arteor™ the ideal choice for every kind of project, anywhere in the world at any installation level. Arteor™ suits any requirement in terms of design and function for every kind of building, from residential to commercial.



TV socket



Bell push



Fan regulator



Skirting light



1-way switch - 3 gang

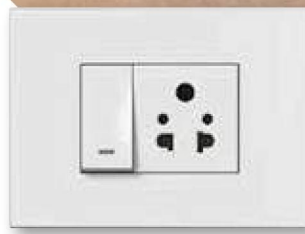

Switch & socket



Power unit





6AX switch\*



Skirting light



PIR Sensor



USB charger



MODERN HOME



Triple RCA socket



Time delay switch

\*Switch compatible with LED light

# ARTEOR™

## OFFICE AND HOTEL SOLUTIONS

Offices and collective spaces require specific solutions and maximum flexibility: lighting adapted to each situation (meeting, conference, etc.), access security, comprehensive multimedia connections. The Arteor™ range meets all these expectations with perfect adaptability.

**OFFICE**

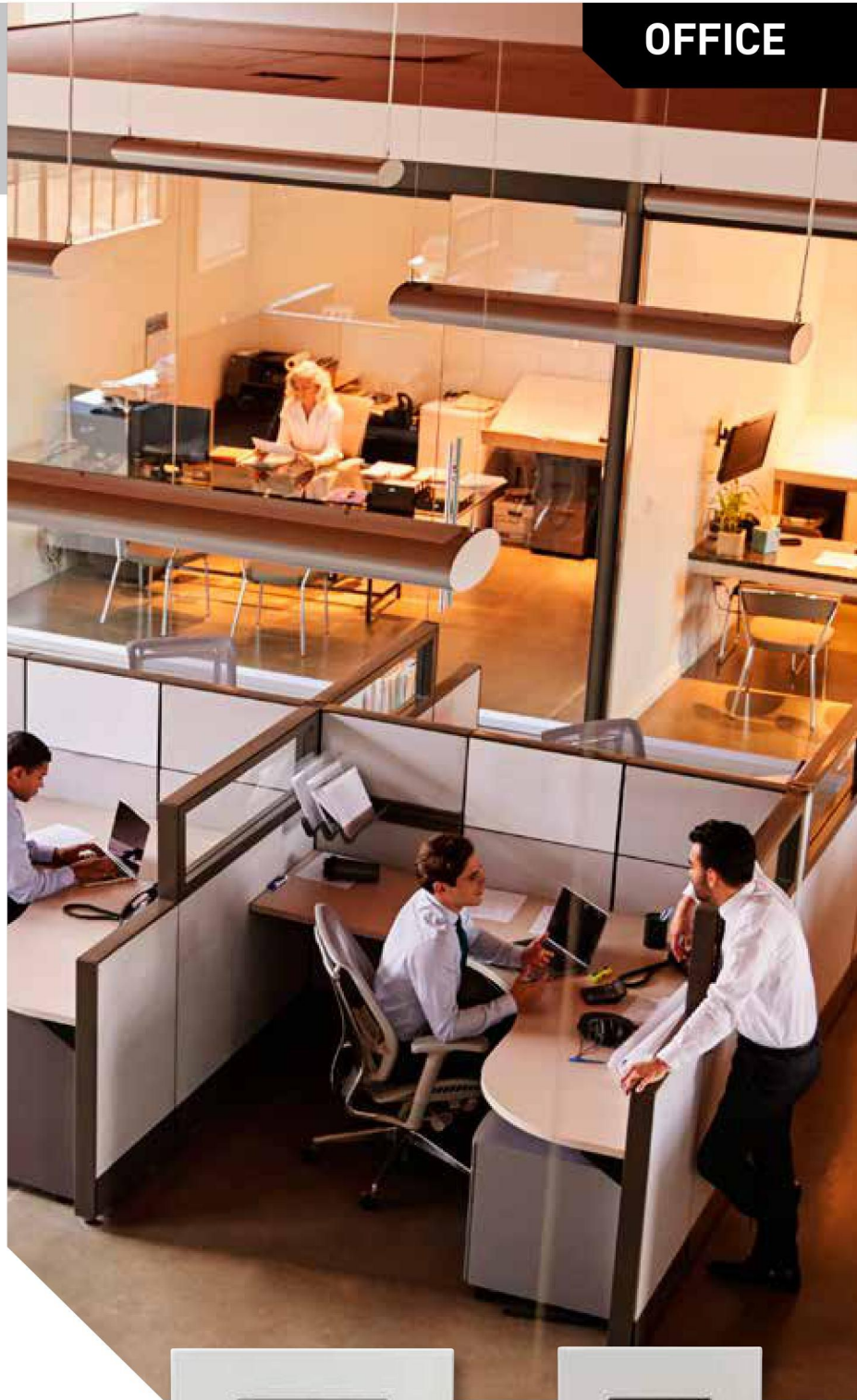

Automatic switch

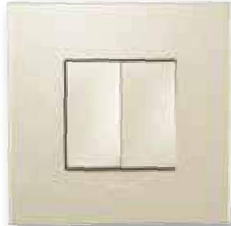

6 A 1 way switch



USB socket



RJ45



Preterminated HDMI sockets



Female HD15 + Jack



Universal touch dimmer\*



Universal dimmer\*

\*For all loads including LED



**HOTEL**

From hotel room door to the beside table, Arteor™ provides all the solutions for the specific need of today's hotel industry. Comfort that extends to the hotel's communal areas, whether dedicated to the relaxation or work. The multitude of small details, gives the comfort feeling of being at home to the traveller.



Data sockets



4-Scenario touch control



S-Video socket



Keycard switch



External unit



Desk and entrance light



TV/R/SAT



Bed light and curtain aswitch



Internal unit





# ARTEOR™

A RICH CHOICE  
OF FINISHES

## NEUTRAL



## MIRROR



## GRAPHIC



## METAL



Graphite



Dark Bronze



Green Apple

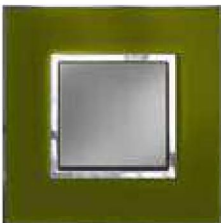

Dark Baroque



**WOOD**

Grey Oak



**SIGNATURE**

Cube



# ARTEOR™

VERSATILITY AND  
MODULARITY FOR  
UNRIVALLED  
FLEXIBILITY

Arteor™ is a modular range offering maximum flexibility in terms of installation and configuration.





## Features that set ARTEOR™ apart



- ① Finger-proof terminals for IP 20 protection against accidental contact.
- ② Captive "never to loose screws"



- ① Tunnel terminals preventing screwdrivers from slipping.
- ② Laser marking on mechanisms. Arrow showing the correct orientation of the mechanism.
- ③ The latest IS 3854 : 1997.



Sockets with ISI mark, conforming to IS 1293. Fan regulator with ISI mark, conforming to IS 11037.



Fully shrouded internal mechanism under the rocker preventing visibility of sparks.



- ① Stripping templates on sockets for stripping off exact length of insulation.



Sockets are shuttered for child's safety against electric shocks.



Possibility of weather proofing mechanisms using Plexo IP 55 and IP 66 boxes.



For switches with LED lamps, life of LED is 50000 burning hours. Consumes power (0.76W) next to NIL.

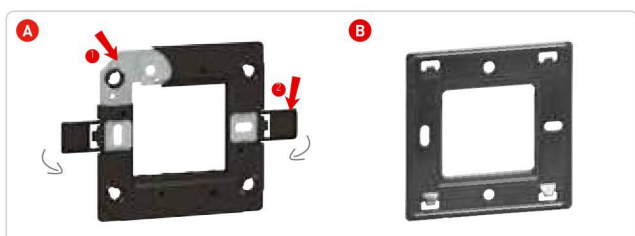

A. For all high end plates  
Metal frame providing solid support to base.  
Bi-material frame - electrical safety IP20.  
Screw caps can be closed once the support frame is installed, ensuring total insulation.



2x2 way switch - 3 controls possible in 2 module plate. In round and square design possible.



Mechanisms compatible with DLP trunking systems, columns, floor boxes and VDI installations.

# ARTEOR™ MyHOME\_UP

## THE BEAUTIFUL SIMPLICITY OF HOME AUTOMATION

Put the finishing touch to your homes with the hometouch screen. get total control of your home with just a touch. see the full range of home automation solutions provided by arteor MyHOME\_Up on [legrand.co.in](http://legrand.co.in)

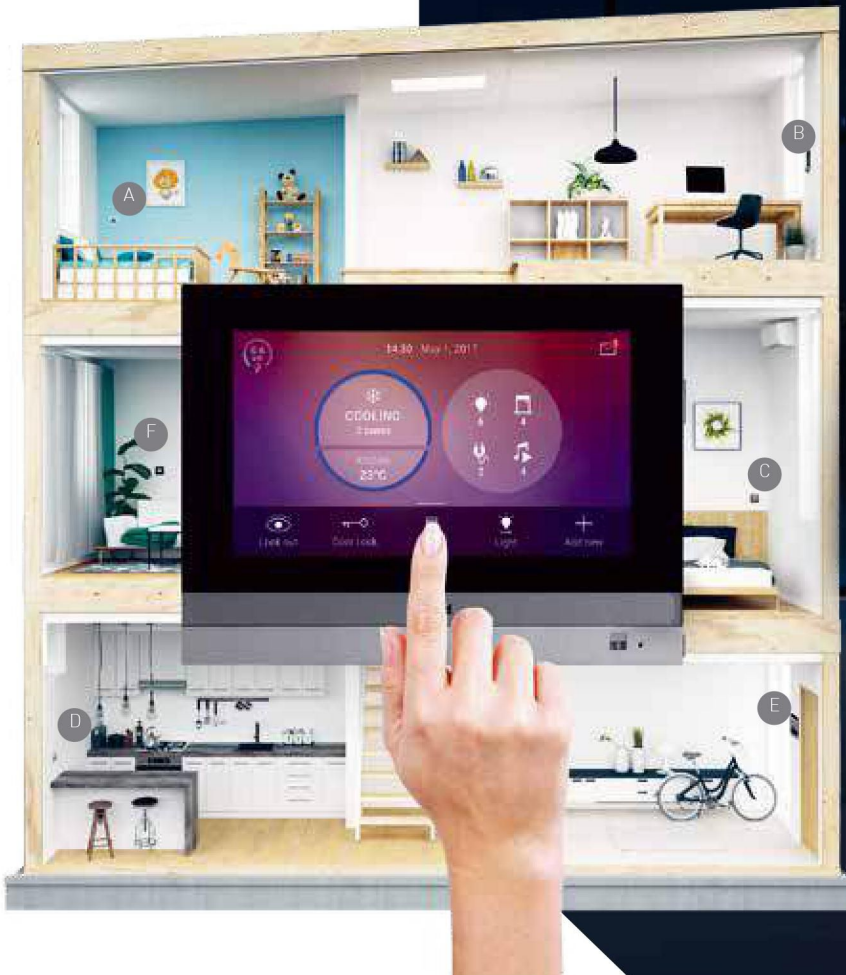

# THE FINISHING TOUCH

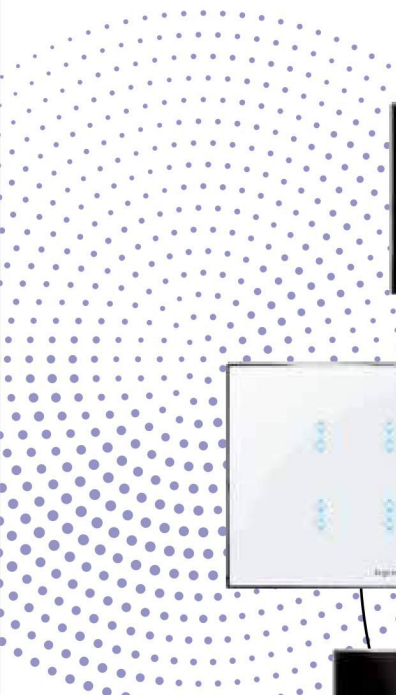











## Arteor™ square - white mechanisms

Cat.Nos	Description	MRP* ₹ / Unit	Pack
---------	-------------	---------------------	------





### Switches – 6 A - 250 V AC

 5734 01	Switch - 6 A - SP - 1 way 1 module	192	20/200
 5734 01	Switch - 6 A - SP - 1 way with indicator - 1 module	308	20/200
 5734 02	Switch - 6 A - SP - 2 way 1 module	274	20/200
 5734 03	Switch - 6 A - SP - 2 way with indicator - 1 module	388	20/200

### Switches – 10 A - 250 V AC

 5734 50	Switch - 10 A - SP - 1 way 2 module	318	10/100
 5734 51	Switch - 10 A - SP - 2 way 2 module	376	10/100
 5720 37	Switch - 10 A - SP - 2 way with indicator & label holder - 2 module	1776	10/100
 5720 38	Intermediate switch - 2 module	2126	10/100

### Switches – 20 A - 250 V AC





 5734 10	Switch - 20 A - SP - 1 way - 1 module	364	20/200
 5734 52	Switch - 20 A - SP - 1 way - 2 module	432	10/100
 5720 63	Switch - 20 A - SP - 1 way with indicator - 1 module	374	20/200
 5734 11	Switch - 20 A - SP - 2 way with indicator - 1 module	522	20/200

\* MRP - Maximum Retail Price Inclusive of all taxes including GST.  
■ Price available on request

## Arteor™ square - white mechanisms

Cat.Nos	Description	MRP* ₹ / Unit	Pack
---------	-------------	---------------------	------

### Switches – 20 A - 250 V AC

 5720 42	Switch - 20 A - SP - 2 way with indicator - 2 module	568	10/100
 5720 43	Switch - 20 A - 3 gang - 1 way - 2 module	1020	10/100
 5720 44	Switch - 20 A - 3 gang - 2x2 way + 1x1 way - 2 module	1118	10/100
 5734 54	Switch - 20 A - DP - 1 way with indicator - 2 module	802	10/100
 5720 49	Switch - 20 A - DP - 1 way with indicator and water heater marking - 2 module	842	10/100

### Accessory for switch with indicator

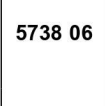
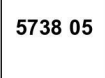
 5738 06	LED for switch with indicator (blue)	64	5/50
 5738 05	LED for switch with indicator (red)	54	5/50

### Switches – 25 A - 230 V AC

 5734 17	25 A switch with indicator	484	20/200
---	----------------------------	-----	--------

### Switches – 32 A / 40 A - 250 V AC

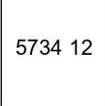
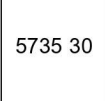
 5734 12	Switch - 32 A - DP - 1 way with indicator - 2 module	1146	10/100
 5735 30	Switch - 40 A - DP - 1 way with indicator - fits on 1/2 module box	1322	1/5/20

### Push button – 6 A - 250 V AC

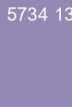
 5734 13	Bell push - 6 A - SP - 1 way - 1 module	294	20/200
 5734 59	Bell push - 6 A - SP - 1 way - 2 module	410	10/100

Bold Cat.Nos are products normally available with Legrand (India) Stockists.  
Cat.Nos that are not bold - delivery within 4 - 8 weeks from the date of order.  
Bold packing quantity is our mandatory packing. Orders to be placed by  
Legrand (India) Stockist in multiples of the same.

## Arteor™ square - white mechanisms

Cat.Nos	Description	MRP* ₹ / Unit	Pack
---------	-------------	---------------------	------

### Push button – 6 A - 250 V AC

5734 04	Push button - 6 A - SP - 1 way - 1 module	308	20/200
5734 05	Push button- 6 A-SP - 1 way with indicator - 1 module	392	20/200
5734 14	Bell push - 6 A-SP - 1 way with indicator - 1 module	388	20/200
5734 60	Bell push - 6 A-SP - 1 way with indicator - 2 module	550	10/100



5734 05



5722 20

### Electric roller blinds control

5722 20	Double switch for electric shutter - 2 module	716	10/100
---------	--	-----	--------

### Dimmers and fan regulators

5734 62	Light dimmer 60 to 400 watts - 2 module	1148	10/100
5734 16	Fan step regulator 100 watts - 1 module	948	1/5/50
5734 63	Fan step regulator 100 watts - 2 module	1170	1/10/100
5734 69	Fan step regulator 120 watts - 2 module (for 48 & 56" fans)	1248	1/10/100
5734 68	Fan step regulator - 2 module for energy saving fans	1244	1/10/100



5734 63

### Electronic dimmers

5734 65	Universal touch dimmer 3 M	7194	1/10
5722 39	Universal dimmer without neutral 400 W - 2 module	10534	1/10



5722 39

\* MRP - Maximum Retail Price Inclusive of all taxes including GST.  
■ Price available on request

## Arteor™ square - white mechanisms

Cat.Nos	Description	MRP* ₹ / Unit	Pack
---------	-------------	---------------------	------

### Indian standard sockets

5734 70	Socket shuttered - 6 A - 2/3 pin - universal India 2 module	362	20/200
5734 71	Socket shuttered - 6/16 A - 3 pin - Indian - 2 module	478	10/100
5734 67	Socket shuttered - 6/16 A - 3 pin - Indian - 3 module	576	5/50
5734 72	Socket - 13 A - 3 pin - 2P+E BS - 2 module	750	10/100
5735 10	Socket with switch - 16 A - 3 pin - 2P+E - Indian - 3 module	1356	5/50
5720 59	Socket - 15/16 A - 2P - Euro/US - 1 module	386	10/100
5737 79	Socket - 6 A/13 A/15 A for 127 V, - double multistandard - 4 module	832	5/50
5734 73	Multistandard socket - 6/10/13 A - 2/3 pin for 250 V AC, 15 A for 127 V type - 2 pin - 2 module	454	10/100
5734 66	25 A socket - 2 module	582	10/100
5721 16	Euro/US - 15 A-127 V/16 A - 250 V, 2P + E with shutter 2 module	674	10/100



5734 71



5734 72



5734 73

Bold Cat.Nos are products normally available with Legrand (India) Stockists.  
Cat.Nos that are not bold - delivery within 4 - 8 weeks from the date of order.  
Bold packing quantity is our mandatory packing. Orders to be placed by  
Legrand (India) Stockist in multiples of the same.

## Arteor™ square - white mechanisms

Cat.Nos	Description	MRP* ₹ / Unit	Pack
---------	-------------	------------------	------

### Energy plugs

5738 86	6 A plug	124	1/10/100
5738 88	16 A plug	164	1/10/100
5738 07	25 A plug	188	1/10/100

### USB chargers (IS13252 (Part 1) / IEC 60950-1)

<b>5734 41</b>	USB Charger 1 M 1500 mA	1836	1/5/50
<b>5734 22</b>	Double USB Charger 2 M 2400 mA	2548	1/10/100

### RJ 11 telephone sockets (Jack type)

5734 27	Telephone socket - double RJ11 - 1 module	422	20/200
<b>5734 26</b>	Telephone socket - RJ11 with shutter - 1 module	246	20/200

### Information outlets - toolless

<b>5734 29</b>	Information socket - category 5e-UTP - 1 module	584	20/200
<b>5734 75</b>	Information socket - category 5e-UTP - 2 module	626	10/100
<b>5734 28</b>	Information socket - category 6-UTP - 1 module	898	20/200
<b>5734 74</b>	Information socket - category 6-UTP - 2 module	942	10/100

### TV sockets

<b>5734 25</b>	TV Co-Axial socket - 1 module	256	20/200
----------------	----------------------------------	-----	--------

### Electronic chime

5734 43	Bell ding dong 230V - 2 module	388	1/10/100
---------	-----------------------------------	-----	----------

### Buzzer

<b>5734 42</b>	Buzzer - 230 V - 1 module	1380	20/200
----------------	------------------------------	------	--------

### Bell call indicator & register - 6A - 250V AC

5734 15	Bell call indicator with register - 6 A - 1 way - SP - 1 module	1724	20/200
5736 06	Set of labels for bell call indicator (1-20)	466	5/50

### Lighting

<b>5734 64</b>	Skirting light with LED - 230 V - 3 module	928	1/5/25
5722 26	Skirting light with detector (LED) - 230 V - 2 module	14922	1/20
5722 34	Miniature emergency skirting light unit - 2 module	9352	1/20
5724 53	Over door light unit (Red) 2 module	520	10/100
5722 23	Over door light unit (White) 2 module	426	10/100
5724 52	Indicator unit with transparent LED with coloured labels - 1 module	692	10/100

\* MRP - Maximum Retail Price Inclusive of all taxes including GST.

■ To be Introduced Shortly

(1) Supplied with white plate

■ Price available on request

## Arteor™ square - white mechanisms

Cat.Nos	Description	MRP* ₹ / Unit	Pack
---------	-------------	------------------	------

### Power strip and power units

5737 80	Set of 3 multistandard socket + Switch pre-wired - 8 module	2430	1/10
5735 42 <sup>(1)</sup>	1 Power unit (AC & Geyser) 16 A - 4 module	1526	1/5
5721 54	Power unit (AC & Geyser) 32 A (with cable output)	1718	1/5

### MCB

5723 61	MCB - 16 A-SPN - 2 module	3938	1
---------	------------------------------	------	---

### RCBO

5734 85	RCBO - 16 A-SPN - 2 module	13438	1
---------	-------------------------------	-------	---

### Protectors

5734 40	Surge protector - 1 module	4104	20/200
5734 48	Surge protector - 2 module	4794	10/100

### Hotel "DND and MMR" functions

5734 61	DND and MMR indicator with bell push 1+1 module	1852	5/50
5734 58	Internal control unit for DND & MMR 1+1 module	1328	10/100

### Hotel keycard switch

5722 44	16 A key card switch 230 V 2 module	5058	1/20
5722 59	Key fob for above	1380	10/50

### Shaver socket

5721 53	Shaver socket 230 V / 120 - 230 V with earth connector	5262	1
---------	--	------	---

### Infrared sensors

5740 47	PIR sensor with neutral 2 module	7746	1/20
5740 09	PIR sensor without neutral - 2 module	7282	1/20

### Time switch

5720 55	Time delay switch 2 module	6646	1/20
---------	----------------------------	------	------

### Audio-video sockets

5722 72	Double RCA socket (audio) 1 module	■	1/20
5722 73	Triple RCA socket (audio & video) 1 module	■	1/20
5722 74	Female 3.5 mm Jack - 1 module	■	1/20
5722 76	Female BNC 75 jack - 1 module	■	1/20
5722 83	Female XLR jack - 2 module	■	1/20
5723 70	Kit HD 15 + jack amplified transceiver	■	1
5720 97	Preterminated sockets Female HD15 - 1 module	■	1
5720 96	Preterminated sockets HDMI 1.4 - 1 module	■	1

Bold Cat.Nos are products normally available with Legrand (India) Stockists. Cat.Nos that are not bold - delivery within 4 - 8 weeks from the date of order. Bold packing quantity is our mandatory packing. Orders to be placed by Legrand (India) Stockist in multiples of the same.



## Arteor™ square - white mechanisms

Cat.Nos	Description	MRP* ₹ / Unit	Pack
---------	-------------	------------------	------

### Audio-video sockets

5722 84	Line dying down 100 V (25-30W) 2 module	■	1
5722 77	Male XLR jack 2 module	■	1/20
5722 78	Female 3.5 mm Jack - solder - 1 module	■	1/20
5722 75	USB socket - 1 module	■	1/20
5744 01	S-VIDEO socket - 1 module	■	1/40
5722 88	Female HD15 + Jack 3.5 mm - 2 module	■	1/20

### Cable outlet

5734 80	45 A cable outlet 2 module	1032	5/50
5734 33	Cord outlet with 8 mm diameter - 1 module	330	20/200
5734 79	Standard cord outlet - 2 module	470	10/100

### Blanking plate

5734 49	1 module blank	50	20/200
5723 44	2 modules blank	72	10/100
5758 10	Blanking plate + frame - 2 module	420	10/100

### Mounting accessories for panel

5760 15	Panel mounting support - 1 module	274	10/100
5760 16	Panel mounting support - 2 module	290	10/100
5760 50	DIN rail support 2 module	344	10/100

## Square - magnesium mechanisms

### Switches – 6 A - 250 V AC

5736 00	Switch - 6 A-SP - 1 way - 1 module	220	20/200
5736 01	Switch - 6 A-SP - 1 way with indicator - 1 module	356	20/200
5736 02	Switch - 6 A-SP - 2 way - 1 module	318	20/200
5736 03	Switch - 6 A-SP - 2 way with indicator - 1 module	452	20/200

### Switches – 10 A - 250 V AC

5736 50	Switch - 10 A-SP - 1 way - 2 module	338	10/100
5736 51	Switch - 10 A-SP - 2 way - 2 module	402	10/100
5725 37	Switch - 10 A-SP - 2 way with indicator & label holder - 2 module	2000	10/100
5725 38	Intermediate switch - 2 module	2448	10/100

### Switches – 20 A - 250 V AC

5736 10	Switch - 20 A-SP - 1 way 1 module	410	20/200
5736 52	Switch - 20 A-SP - 1 way 2 module	482	10/100

## Arteor™ square - magnesium mechanisms

Cat.Nos	Description	MRP* ₹ / Unit	Pack
---------	-------------	------------------	------

### Switches – 20 A - 250 V AC

5725 63	Switch - 20 A-SP - 1 way with indicator - 1 module	432	20/200
5736 11	Switch - 20 A-SP - 2 way with indicator - 1 module	590	20/200
5725 42	Switch - 20 A-SP - 2 way with indicator - 2 module	634	10/100
5725 43	Switch - 20 A-3 gang - 1 way - 2 module	1170	10/100
5725 44	Switch - 20 A-3 gang - 2x2 way + 1x1 way - 2 module	1222	10/100
5736 54	Switch 20 A-DP - 1 way with indicator - 2 module	948	10/100
5725 49	Switch - 20 A-DP - 1 way with indicator and water heater marking - 2 module	1008	10/100

### Switches – 25 A - 230 V AC

5736 17	25A switch with indicator	542	20/200
---------	---------------------------	-----	--------

### Switches – 32 A / 40 A - 250 V AC

5736 12	Switch - 32 A-DP - 1 way with indicator - 2 module	1322	10/100
5737 30	Switch - 40 A-DP - 1 way with indicator - fits on 1/2 module box	1520	1/5/20

### Push button – 6 A - 250 V AC

5736 13	Bell push - 6 A-SP - 1 way - 1 module	330	20/200
5736 59	Bell push - 6 A-SP - 1 way - 2 module	470	10/100
5736 04	Push button - 6 A-SP - 1 way - 1 module	340	20/200
5736 05	Push button - 6 A-SP - 1 way with indicator - 1 module	454	20/200
5736 14	Bell push - 6 A-SP - 1 way with indicator - 1 module	452	20/200
5736 60	Bell push - 6 A-SP - 1 way with indicator - 2 module	630	10/100

### Electric roller blinds control

5727 20	Double switch for electric shutter - 2 module	826	10/100
---------	--	-----	--------

### Dimmers and fan regulators

5736 62	Light dimmer - 60 to 400 watts - 2 module	1324	10/100
5736 16	Fan step regulator - 100 watts - 1 module	1088	1/5/50
5736 63	Fan step regulator - 100 watts - 2 module	1348	1/10/100
5736 69	Fan step regulator - 120 watts - 2 module ( for 48 & 56" fans )	1438	1/10/100
5736 68	Fan step regulator - 2 module for energy saving fan	1428	1/10/100

### Electronic dimmer

5727 39	Universal dimmer without neutral 400 W - 2 module	11402	1/10
---------	--	-------	------

\* MRP - Maximum Retail Price Inclusive of all taxes including GST.  
■ Price available on request

Bold Cat.Nos are products normally available with Legrand (India) Stockists.  
Cat.Nos that are not bold - delivery within 4 - 8 weeks from the date of order.  
Bold packing quantity is our mandatory packing. Orders to be placed by  
Legrand (India) Stockist in multiples of the same.

## Arteor™ square - magnesium mechanisms



5736 70



5736 71



5739 79

Cat.Nos	Description	MRP* ₹ / Unit	Pack
<b>Indian standard sockets</b>			
5736 70	Socket shuttered - 6 A - 2/3 pin - universal India - 2 module	418	20/200
5736 71	Socket shuttered - 6/16 A - 3 pin - Indian - 2 module	550	10/100
5736 67	Socket shuttered - 6/16 A - 3 pin - Indian - 3 module	674	5/50
5736 72	Socket - 13 A - 3 pin - 2P+E BS - 2 module	868	10/100
5737 10	Socket with switch - 16 A - 3 pin - 2P+E - Indian 3 module	1558	5/50
5720 86	Socket - 15/16 A - 2P - Euro/US - 1 module	446	10/100
5739 79	Socket w - 6 A/13 A/15 A for 127 V, - double multistandard - 4 module	954	5/50
5736 73	Multistandard socket - 6/10/13 A - 2/3 pin for 250 V AC 15 A for 127 V type - 2 pin 2 module	510	10/100
5736 66	25 A socket - 2 module	672	10/100
5726 16	Euro/US 15 A-127 VA/16 A 230 V 2P+E with shutter 2 M	798	10/100

### USB chargers (IS13252 (Part 1) / IEC 60950-1)

NEW!

5734 44	USB Charger 1M 1500 mA	2120	1/5/50
5736 22	Double USB Charger 2M 2400mA	2932	1/10/100

### RJ 11 telephone sockets (Jack type)



5736 27

5736 27	Telephone socket - double RJ11 - 1 module	484	20/200
5736 26	Telephone socket - RJ11 with shutter - 1 module	296	20/200

### Information outlets - toolless



5736 28

5736 29	Information socket - category 5e - UTP - 1 module	672	20/200
5736 75	Information socket - category 5e - UTP - 2 module	722	10/100
5736 28	Information socket - category 6 - UTP - 1 module	1026	20/200
5736 74	Information socket - category 6 - UTP - 2 module	1078	10/100

### TV sockets



5736 25

5736 25	TV Co-Axial socket - 1 module	302	20/200
---------	-------------------------------	-----	--------

### Electronic chime

5736 43	Bell ding dong 230 V - 2 module	416	10/100
---------	---------------------------------	-----	--------

\* MRP - Maximum Retail Price Inclusive of all taxes including GST.

■ To be Introduced Shortly

(1) Supplied with white plate

■ Price available on request

## Arteor™ square - magnesium mechanisms



5736 42



5735 64



5737 42



5736 61



5727 44



5726 53



5727 59



5727 44



5726 53

Cat.Nos	Description	MRP* ₹ / Unit	Pack
<b>Buzzer</b>			
5736 42	Buzzer- 230 V - 1 module	1512	20/200
<b>Bell call indicator &amp; register - 6A - 250V AC</b>			
5735 64	Bell call indicator with register - 6 A - 1 way - SP - 1 module	1990	20/200
<b>Lighting</b>			
5735 64	Skirting light with LED - 230 V - 3 module	1068	1/5/25
5727 26	Skirting light with detector (LED) - 230 V - 2 module	17156	1/20
<b>Power strip and power units (without plate)</b>			
5739 80	Set of 3 multistandard socket + switch pre-wired - 8 module	2786	1/10
5737 42 <sup>(3)</sup>	Power unit (AC & Geyser) 16 A - 4 module	1770	1/5
5726 54	Power unit (AC & Geyser) 32 A (with cable output) 4 module	2012	1/5
<b>Hotel "DND and MMR " functions</b>			
5736 61	DND and MMR indicator with bell push 1+1 module	2126	5/50
5736 58	Internal control unit for DND & MMR 1+1 module	1536	10/100
<b>Hotel keycard switch</b>			
5727 44	16 A Key card switch 230 V with time delay - 2 module	5572	1/20
5727 59	Key fob for above	1918	10/50
<b>Shaver socket</b>			
5726 53	Shaver socket 230 V / 120-230 V with earth connector	5794	1
<b>Infrared sensors</b>			
5740 97	PIR sensor with neutral - 2 module	8912	1/20
5740 59	PIR sensor without neutral - 2 module	8910	1/20
<b>Time switch</b>			
5740 84	Time delay switch - 2 module	7356	1/20
<b>Audio-video sockets</b>			
5727 72	Double RCA socket (audio) - 1 module	■	1/20
5727 73	Triple RCA socket (audio & video) - 1 module	■	1/20
5727 74	Female 3.5 mm Jack - 1 module	■	1/20
5727 76	Female BNC 75 jack - 1 module	■	1/20

Bold Cat.Nos are products normally available with Legrand (India) Stockists. Cat.Nos that are not bold - delivery within 4 - 8 weeks from the date of order. Bold packing quantity is our mandatory packing. Orders to be placed by Legrand (India) Stockist in multiples of the same.



## Arteor™ square - magnesium mechanisms

Cat.Nos	Description	MRP* ₹ / Unit	Pack
---------	-------------	------------------	------

### Audio-video sockets

5727 83	Female XLR jack - 2 module	■	1/20
5728 70	Kit HD 15 + Jack Amplified transceiver - 3*4 module	■	1
5725 97	Preterminated sockets Female HD15 - 1 module	■	1

### Audio-video sockets

5725 96	Preterminated sockets HDMI 1.4 - 1 module	■	1
5727 84	Line dying down 100 V (25-30 W) 2 module	■	1
5727 77	Male XLR jack 2 module	■	1/20
5727 78	Female 3.5 mm Jack - solder - 1 module	■	1/20
5727 75	USB socket - 1 module	■	1/20
5744 51	S-VIDEO socket - 1 module	■	1/40
5727 88	Female HD15 + Jack 3.5 mm - 2 module	■	1/20

### Blanking plate

5736 49	1 module blank	50	20/200
5728 44	2 modules blank	80	10/100

### Dedicated switches

5738 00	Dedicated switch - 6 A - 1 way - SP - red - 1 module	262	20/200
5738 01	Dedicated switch - 10 A - 1 way - SP - red - 1 module	264	20/200
5738 02	Dedicated switch - 20 A - 1 way - DP - red - 1 module	916	5/40

### Tamper proof and dedicated sockets

5738 08	Tamperproof red Indian socket 6 A (2/3 pin) - 2 module	730	20/200
5738 10	Dedicated socket with switch - 16 A - 3 pin - 2P+E - Indian - 3 module	1912	5/50
5738 09	Insert for tamper proof Indian socket - 6 A	96	1/20/200

### Square - Champagne mechanisms

#### Switches - 6 A - 250 V AC

5748 00	Switch - 6 A-SP - 1 way - 1 module	220	20/200
5748 01	Switch - 6 A-SP - 1 way with indicator - 1 module	356	20/200
5748 02	Switch - 6 A-SP - 2 way - 1 module	318	20/200
5748 03	Switch - 6 A-SP - 2 way with indicator - 1 module	452	20/200



5748 05



5748 07



5748 11



5748 15



5748 16



5748 17



5748 18



5748 23



5748 26



5748 20

## Arteor™ square - champagne mechanisms

Cat.Nos	Description	MRP* ₹ / Unit	Pack
---------	-------------	------------------	------

### Switches - 10 A - 250 V AC

5748 04	Switch - 10 A-SP - 1 way - 2 module	338	10/100
5748 05	Switch - 10 A-SP - 2 way - 2 module	402	10/100
5748 06	Switch - 10 A-SP - 2 way with indicator & label holder - 2 module	2000	10/100
5748 07	Intermediate switch - 2 module	2448	10/100

### Switches - 20 A - 250 V AC

5748 08	Switch - 20 A-SP - 1 way 1 module	410	20/200
5748 09	Switch - 20 A-SP - 1 way 2 module	482	10/100
5748 10	Switch - 20 A-SP - 1 way with indicator - 1 module	432	20/200
5748 11	Switch - 20 A-SP - 2 way with indicator - 1 module	590	20/200
5748 12	Switch - 20 A-SP - 2 way with indicator - 2 module	634	10/100
5748 13	Switch - 20 A-3 gang - 1 way - 2 module	1170	10/100
5748 14	Switch - 20 A-3 gang - 2x2 way + 1x1 way - 2 module	1222	10/100
5748 15	Switch 20 A-DP - 1 way with indicator - 2 module	948	10/100
5748 16	Switch - 20 A-DP - 1 way with indicator and water heater marking - 2 module	1008	10/100

### Switches - 25 A - 230 V AC

5748 17	25A switch with indicator	542	20/200
---------	---------------------------	-----	--------

### Switches - 32 A / 40 A - 250 V AC

5748 18	Switch - 32 A-DP - 1 way with indicator - 2 module	1322	10/100
5748 19	Switch - 40 A-DP - 1 way with indicator - fits on 1/2 module box	1520	1/5/20

### Push button - 6 A - 250 V AC

5748 23	Bell push - 6 A-SP - 1 way - 1 module	330	20/200
5748 24	Bell push - 6 A-SP - 1 way - 2 module	470	10/100
5748 21	Push button - 6 A-SP - 1 way - 1 module	340	20/200
5748 22	Push button - 6 A-SP - 1 way with indicator - 1 module	454	20/200
5748 25	Bell push - 6 A-SP - 1 way with indicator - 1 module	452	20/200
5748 26	Bell push - 6 A-SP - 1 way with indicator - 2 module	630	10/100

### Electric roller blinds control

5748 20	Double switch for electric shutter - 2 module	826	10/100
---------	---	-----	--------

\* MRP - Maximum Retail Price Inclusive of all taxes including GST.  
Red Cat.Nos - new products  
■ Price available on request.

Bold Cat.Nos are products normally available with Legrand (India) Stockists.  
Cat.Nos that are not bold - delivery within 4 - 8 weeks from the date of order.  
Bold packing quantity is our mandatory packing. Orders to be placed by Legrand (India) Stockist in multiples of the same.



## Arteor™ square - champagne mechanisms

Cat.Nos	Description	MRP* ₹ / Unit	Pack
---------	-------------	------------------	------

### Dimmers and fan regulators

5748 27	Light dimmer - 60 to 400 watts - 2 module	1366	10/100
5748 29	Fan step regulator - 100 watts - 1 module	1088	1/5/50
5748 30	Fan step regulator - 100 watts - 2 module	1348	1/10/100
5748 31	Fan step regulator - 120 watts - 2 module ( for 48 & 56" fans )	1438	1/10/100
5748 32	Fan step regulator - 2 module for energy saving fan	1428	1/10/100

### Indian standard sockets

5748 33	Socket shuttered - 6 A - 2/3 pin - universal India - 2 module	416	20/200
5748 34	Socket shuttered - 6/16 A - 3 pin - Indian - 2 module	550	10/100
5748 35	Socket shuttered - 6/16 A - 3 pin - Indian - 3 module	674	5/50
5748 39	Socket w - 6 A/13 A/15 A for 127 V, - double multistandard - 4 module	954	5/50
5748 40	Multistandard socket - 6/10/13 A - 2/3 pin for 250 V AC 15 A for 127 V type - 2 pin 2 module	510	10/100
5748 41	25 A socket - 2 module	672	10/100

### USB chargers (IS13252 (Part 1) / IEC 60950-1)

5734 47	USB Charger 1M 1500 mA	2120	1/5/50
5748 44	Double USB Charger 2M 2400mA	2932	1/10/100

### RJ 11 telephone sockets (Jack type)

5748 45	Telephone socket - double RJ11 - 1 module	484	20/200
5748 46	Telephone socket - RJ11 with shutter - 1 module	296	20/200

### Information outlets - toolless

5748 47	Information socket - category 5e - UTP - 1 module	672	20/200
5748 48	Information socket - category 5e - UTP - 2 module	722	10/100
5748 49	Information socket - category 6 - UTP - 1 module	1026	20/200
5748 50	Information socket - category 6 - UTP - 2 module	1078	10/100

### TV sockets

5748 51	TV Co-Axial socket - 1 module	302	20/200
---------	-------------------------------	-----	--------

\* MRP - Maximum Retail Price Inclusive of all taxes including GST.  
 \* To be Introduced Shortly  
 Red Cat.Nos - new products  
 (1) Supplied with white plate  
 ■ Price available on request

## Arteor™ square - champagne mechanisms

Cat.Nos	Description	MRP* ₹ / Unit	Pack
---------	-------------	------------------	------

### Electronic chime

5748 52	Bell ding dong 230 V - 2 module	416	10/100
---------	---------------------------------	-----	--------

### Buzzer

5748 53	Buzzer- 230 V - 1 module	1512	20/200
---------	--------------------------	------	--------

### Bell call indicator & register - 6A - 250V AC

5748 54	Bell call indicator with register - 6 A - 1 way - SP - 1 module	1990	20/200
---------	---	------	--------

### Lighting

5748 55	Skirting light with LED - 230 V - 3 module	1068	1/5/25
---------	--	------	--------

### Hotel "DND and MMR" functions

5748 56	DND and MMR indicator with bell push 1+1 module	2126	5/50
5748 57	Internal control unit for DND & MMR 1+1 module	1536	10/100

### Hotel keycard switch

5748 58	16 A Key card switch 230 V with time delay - 2 module	5572	1/20
5727 59	Key fob for above	1918	10/50

### Blanking plate

5748 63	1 module blank	50	20/200
5748 64	2 modules blank	80	10/100

### Round - white mechanisms

#### Switches - 6 A - 250 V AC















5733 00	Switch - 6 A-SP - 1 way left - 1 module	264	20/200
5733 01	Switch - 6 A-SP - 1 way right - 1 module	264	20/200
5733 12	Switch - 6 A-SP - 1 way - middle - 1 module	264	20/200
5733 05	Switch - 6 A-SP - 2 way - left - 1 module	328	20/200
5733 06	Switch - 6 A-SP - 2 way - right - 1 module	328	20/200
5733 02	Switch - 6 A-SP - 1 way with indicator - left - 1 module	374	20/200
5733 04	Switch - 6 A-SP - 1 way with indicator - right - 1 module	374	20/200
5733 03	Switch - 6 A-SP - 1 way with indicator - middle - 1 module	374	20/200
5733 07	Switch - 6 A-SP - 2 way with indicator - left - 1 module	468	20/200
5733 08	Switch - 6 A-SP - 2 way with indicator - right - 1 module	468	20/200

Bold Cat.Nos are products normally available with Legrand (India) Stockists. Cat.Nos that are not bold - delivery within 4 - 8 weeks from the date of order. Bold packing quantity is our mandatory packing. Orders to be placed by Legrand (India) Stockist in multiples of the same.

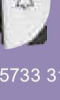
## Arteor™ round - white mechanisms

Cat.Nos	Description	MRP* ₹ / Unit	Pack
---------	-------------	------------------	------







### Switches – 20 A - 250 V AC

 5733 20	Switch - 20 A-SP - 1 way - left - 1 module	438	20/200
 5733 21	Switch - 20 A-SP - 1 way - right - 1 module	438	20/200
 5730 21	Switch - 20 A-SP - 1 way - middle - 1 module	442	20/200
 5733 40	Switch - 20 A-SP - 1 way - 2 module	508	10/100
 5720 64	Switch - 20 A-SP - 1 way with indicator-left - 1 module	450	20/200
 5720 65	Switch - 20 A-SP - 1 way with indicator-right - 1 module	450	20/200
 5730 24	Switch - 20 A-SP - 2 way - middle - 1 module	450	20/200
 5733 22	Switch - 20 A-SP - 2 way with indicator-left - 1 module	626	20/200
 5733 23	Switch - 20 A-SP - 2 way with indicator-right - 1 module	626	20/200
 5730 71	Switch - 20 A-SP - 2 way with indicator - 2 module	552	10/100
 5730 72	Switch - 20 A-3 gang - 1 way - 2 module	1220	10/100
 5730 73	Switch - 20 A-3 gang - 2x2 way+1x1 way - 2 module	1344	10/100
 5733 42	Switch 20 A-DP - 1 way with indicator - 2 module	948	10/100
 5730 27	Switch - 20 A-SP - 2 way with indicator - middle - 1 module	626	20/200

### Switches - 32 A

 5733 26	Switch - 32 A-DP - 1 way with indicator - 2 module	1378	10/100
---	--	------	--------





### Push button – 6 A - 250 V AC

 5733 31	Bell push - 6 A-SP - 1 way - right - 1 module	340	20/200
 5733 30	Bell push - 6 A-SP - 1 way - left - 1 module	340	20/200
 5733 46	Bell push - 6 A-SP - 1 way - 2 module	484	10/100
 5733 09	Push button - 6 A-SP - 1 way - left - 1 module	364	20/200
 5733 11	Push button - 6 A-SP - 1 way - right - 1 module	364	20/200
 5733 47	Bell push - 6 A-SP - 1 way with indicator - 2 module	658	10/100
 5733 10	Push button - 6 A-SP - 1 way - middle - 1 module	364	20/200

### Electric roller blinds control

 5732 20	Double pole switch 10 A - 2 module	862	10/100
---	------------------------------------	-----	--------

### Dimmers and fan regulators

 5730 66	Light dimmer - 60 to 400 Watts - 2 module	1384	1/10/100
 5730 03	Fan step regulator - 100 Watts - 2 module	1404	1/10/100
 5730 69	Fan step regulator - 120 Watts - 2 module	1522	1/10/100
 5730 04	Fan step regulator - 2 module for energy saving fans	1488	1/10/100

\* MRP - Maximum Retail Price Inclusive of all taxes including GST.  
■ Price available on request.

## Arteor™ round - white mechanisms

Cat.Nos	Description	MRP* ₹ / Unit	Pack
---------	-------------	------------------	------

### Electronic dimmer

 5743 19	Universal dimmer without neutral 400 W - 2 module	11672	1/10
---	---	-------	------

### Multistandard sockets

 5734 89	Multistandard socket 6/10/13 A - 2/3 pin for 250 V AC 15 A for 127 V type - 2 pin 2 module	516	10/100
---	--	-----	--------



### USB chargers (IS13252 (Part 1) / IEC 60950-1)

 5734 23	Double USB Charger 2M 2400mA	2820	1/10/100
---	------------------------------	------	----------





### Information outlets - toolless

 5723 24	Information socket - category 6-UTP - 2 module	1200	10/100
---	--	------	--------

### Hotel internal control units

 5720 74	Internal control unit for DND & MMR - 1+1 module	1860	5/50
 5720 67	DND & MMR indicator with bell push - 2 module	2338	5/40

### Audio-video sockets







 5732 72	Double RCA socket (audio) - 2 module	■	1/20
 5732 73	Triple RCA socket (audio & video) - 2 module	■	1/20
 5722 85	HDMI socket - 2 module	■	1/20
 5745 01	S-VIDEO socket - 2 module	■	1/20
 5722 89	Female HD15 + Jack 3.5 mm - 2 module	■	1/20

### Blanking plate





 5730 87	2 modules blank	82	10/100
---	-----------------	----	--------

## Round - magnesium mechanisms

### Switches - 6 A - 250 V AC

 5733 50	Switch - 6 A-SP - 1 way - left - 1 module	308	20/200
 5733 51	Switch - 6 A-SP - 1 way - right - 1 module	308	20/200
 5733 62	Switch - 6 A-SP - 1 way - middle - 1 module	308	20/200
 5733 55	Switch - 6 A-SP - 2 way - left - 1 module	378	20/200
 5733 56	Switch - 6 A-SP - 2 way - right - 1 module	378	20/200
 5733 52	Switch - 6 A-SP - 1 way with indicator - left - 1 module	420	20/200

### Switches - 6 A - 250 V AC

 5733 54	Switch - 6 A-SP - 1 way with indicator - right - 1 module	420	20/200
 5733 53	Switch - 6 A-SP - 1 way with indicator - middle - 1 module	420	20/200
 5733 57	Switch - 6 A-SP - 2 way with indicator - left - 1 module	542	20/200
 5733 58	Switch - 6 A-SP - 2 way with indicator - right - 1 module	542	20/200

Bold Cat.Nos are products normally available with Legrand (India) Stockists. Cat.Nos that are not bold - delivery within 4 - 8 weeks from the date of order. Bold packing quantity is our mandatory packing. Orders to be placed by Legrand (India) Stockist in multiples of the same.



# Myrius™

## More is on.

MORE IS ON



The Myrius's range of plates is crafted with unique features & flawless designs, it perfectly defines aestheticism. These minimalistic and flawless designs are available in neutral tones of grainy matte black and glossy white to suit any décor.



### Black Beauty

A mystic black shade with a grainy matte finish truly complements any décor.

### Snowy White

Its gleaming white shade and a perfect glossy finish creates a soothing décor.

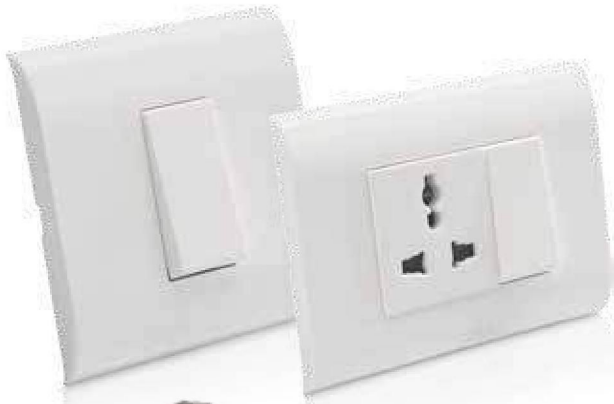

Scan to know more about the product.



## MORE AESTHETICS

Flat, sleek and smooth, Myrius with its curved edges gives it a distinct and appealing look to everyone. Moreover, its minimalistic design makes it look absolutely stunning and desirable. But what makes Myrius truly beautiful is a classic black and white shade that offers an aura of comfort and timelessness.



### VSP - Voltage Surge protectors

- Protects electrical devices like laptops, computers, printers and other office equipments from voltage surge
- Blends very well with the modular range of wiring devices



### Motion sensor

- Infrared detectors that detect human movements
- Programmed to automatically switch the device on and switch off when not in use, thus, saves energy



### Motor Starter

- Complete protection against overload
- Aesthetically appealing
- For ACs/Geysers etc.



### Skirting light

- Fitted into the walls at skirting level
- Provides a dim lighting
- Creates a path light during night
- Uses LEDs that saves energy



### Remote control switch for light and fan

- Can control 4 lights & 1 fan
- 10 different speed options for fan
- Night lamp on product panel with manual operation option for all functions

# Myrius™

More is on.

MORE IS ON



Myrius range of wiring accessories is a classic creation to increase the customer's comfort and improve the work environment. This wide range of innovative products offers solutions for residential, commercial and hospitality projects, thus making it a range that caters to everyone's needs.



Fan regulator



Light Marking



TV/SAT/FM socket



Telephone Socket



AV Connector



RJ 45 Data Socket



Projector connector



Key Fob Switch



Do not disturb Switch



Shaver socket



USB Charger



Modular MCB



## Myrius™ mechanisms - white

Cat.Nos	Description	MRP* ₹ / Unit	Pack
---------	-------------	------------------	------

### Switches - 6 A - 230 VA

6730 00	6 A switch 1 W - 1 module	140	20/200
6730 01	6 A switch 2 W - 1 module	218	20/200
6730 02	6 A switch 1 W - 1 module with indicator	202	20/200
6730 03	6 A switch 1 W - 1 module with "Light" marking	172	20/200
6730 04	6 A switch 1 W - 1 module with "Fan" marking	172	20/200

### Switches - 10 A - 230 VA

6730 05	10 A switch 1 W - 2 module	254	10/100
6730 06	10 A switch 2 W - 2 module	296	10/100
6730 17	10 A intermediate - 2 module	1662	10/100
6730 07	10 A switch 1 W with indicator - 2 module	314	10/100

### Switches - 16 A - 230 VA

6730 08	16 A switch 1 W - 1 module	290	20/200
6730 09	16 A switch 2 W - 1 module	332	20/200
6730 10	16 A switch 1 W with indicator - 1 module	350	20/200

### Switches - 20 A - 230 VA

6730 11	20 A 1 W switch - 1 module	376	20/200
6730 12	20 A DP 1 W switch - 2 module	576	10/100
6730 13	20 A DP 1 W switch with indicator - 2 module	612	10/100
6730 14	20 A 2 W switch - 2 module	638	10/100

### Switches - 25 A - 230 VA

6730 15	25 A SP 1 W switch with indicator - 1 module	422	20/200
---------	--	-----	--------

### Switches - 32 A - 230 VA

6730 16	32 A DP switch with indicator - 2 module	990	10/100
---------	--	-----	--------

\* MRP - Maximum Retail Price Inclusive of all taxes including GST.

## Myrius™ mechanisms - white

Cat.Nos	Description	MRP* ₹ / Unit	Pack
---------	-------------	------------------	------

### Push buttons

6730 18	6 A push button SP - 1 module	250	20/200
6730 19	6 A push button SP with indicator - 1 module	320	20/200
6730 20	6 A bell push - 1 module	238	20/200
6730 21	6 A bell push with indicator - 1 module	314	20/200
6730 22	6 A bell push - 2 module	362	10/100
6730 23	6 A bell push with indicator - 2 module	422	10/100

### Accessories for switches with indicator

6732 44	Lamp for switches / push buttons	52	5/50
---------	----------------------------------	----	------

### Socket - 230 VA

6730 41	6/16 A 2 Pin Euro US socket - 1 module	336	20/200
6730 42	16 A 3 Pin switched socket - 3 module	1078	5/50
6730 43	Multistandard socket 6/10/13 A - 2/3 pin for 250 V AC 15 A for 127 V type - 2 pin 2 module	360	10/100
6730 44	6 A 5 Pin universal socket - 2 module	310	20/200
6730 83	6/16 A socket - 3 module	512	5/50
6730 45	6/16 A socket - 2 module	428	10/100
6730 46	6/16 A - Euro socket - 2 module	494	10/100
6730 47	25 A socket - 2 module	532	10/100

### Power unit

6730 74	Power strip - 8 module 6 A (2 nos.) + 16 A socket (1 no.) + 16 A switch with indicator (1 no.)	2506	1/10
6730 75	Power strip - 8 module 5 Pin 6 A (3 nos.) + 16 A switch with indicator (1 no.)	1966	1/10
6730 76	Power strip - 8 module multistd socket (3 nos.) + 16 A switch (1 no.)	1936	1/10

Bold Cat.Nos are products normally available with Legrand (India) Stockists. Cat.Nos that are not bold - delivery within 4 - 8 weeks from the date of order. Bold packing quantity is our mandatory packing. Orders to be placed by Legrand (India) Stockist in multiples of the same.

## Myrius™ mechanisms - white

Cat.Nos	Description	MRP* ₹ / Unit	Pack
---------	-------------	------------------	------

### Dimmer & regulator

6730 24	Rotary dimmer 400 W - 1 module	1060	1/5/50
6730 25	Rotary dimmer 650 W - 3 module	2228	1/10
6730 26	Compact fluorescent lamp dimmer - 2 module	3328	1/10
6730 27	Fan step regulator 100 W - 1 module	808	1/5/50
6730 29	Fan step regulator 100 W - 2 module	928	1/10/100
6730 28	Fan step regulator 120 W - 2 module	1000	1/10/100
6730 77	Fan step regulator - 2 module for energy saving fans	974	1/10/100

### Emergency light

0785 12	Emergency light unit - 2 module	6186	1/1
---------	---------------------------------	------	-----

### Indicators

0785 73	Triangular bulkhead - Blue - 2 module	270	1/1
0785 71	Triangular bulkhead - colourless - 2 module	270	1/1
0785 72	Triangular bulkhead - green - 2 module	296	1/1
0785 70	Triangular bulkhead - red - 2 module	296	1/1

### Skirting light

6730 36	Skirting light with white LED - 3 module	818	1/5/25
---------	--	-----	--------

### Bell indicator

6730 33	Bell indicator - 240 VA - 1 module	1140	20/200
---------	------------------------------------	------	--------

### Buzzer

6730 34	Buzzer - 230 VA - 1 module	1122	20/200
---------	----------------------------	------	--------

### Remote unit

6730 73	Remote control switch - 4 module	8170	1/5/20
---------	----------------------------------	------	--------

### Hospitality functions Key FOB switch

6730 37	15 A key card switch monobloc with plate - 2 M	3832	1/10
6732 37	15 A key card switch monobloc with new plate - 2M White	4218	1/10
6730 38	Only key fob for switch Cat.Nos 6730 37 & 6732 37	180	1/10/100

## Myrius™ mechanisms - white

Cat.Nos	Description	MRP* ₹ / Unit	Pack
---------	-------------	------------------	------

### "Do Not Distrub" and MMR control unit

6730 39	External unit - 1+1 module	1634	10/100
6730 40	Internal unit - 1+1 module	1092	10/100

### Shaver socket

6730 49	Shaver Socket 230 V / 120 - 230 V monobloc with plate - 4 M	4822	1/5/20
6730 79	Shaver Socket 230 V / 120 - 230 V monobloc with new plate - 4 M White	5056	1/5

### Sockets and connectors

#### TV socket

6730 50	TV socket - 1 module	210	20/200
---------	----------------------	-----	--------

#### Data & voice

6730 52	RJ-11 telephone socket with transparent shutter 1 module	208	20/200
6730 53	RJ-11 double telephone socket with shutter 1 module	318	20/200
6730 54	UTP cat 5e information outlets toolless system 1 module	498	20/200
6730 55	UTP cat 6 - 1 module	738	20/200
6730 56	UTP cat 6 - 2 module	750	10/100

#### USB chargers (IS13252 (Part 1) / IEC 60950-1)

6731 62	#USB Charger 1M 1500mA	1456	10/100
6731 78	Double USB Charger 2M 2400mA	2040	1/10/100

#### Audio & video connector

6730 57	3 x female RCA 1 module	2862	1/10
---------	-------------------------	------	------

#### Sound (Volume controller)

6730 63	Suitable for 8 Ohms, 3W (RNS) speaker - 2	1366	1/10/100
---------	---	------	----------

#### Protectors and accessories

##### Motor starter

6730 30	16A motor starter 2 module	670	1/10/100
6730 31	25A motor starter 2 module	686	1/10/100

##### Modular MCB (IS : 60898-1:2002)

6730 64	16A MCB SP 1M C curve	414	1/10/100
6730 65	20A MCB SP 1M C curve	414	1/10/100
6732 05	25A MCB SP 1M C curve	414	1/10/100
6732 07	32A MCB SP 1M C curve	414	1/10/100

\* MRP - Maximum Retail Price Inclusive of all taxes including GST.  
\* To be Introduced Shortly

Bold Cat.Nos are products normally available with Legrand (India) Stockists. Cat.Nos that are not bold - delivery within 4 - 8 weeks from the date of order. Bold packing quantity is our mandatory packing. Orders to be placed by Legrand (India) Stockist in multiples of the same.



**Myrius™**  
mechanisms - white

Cat.Nos	Description	MRP* ₹ / Unit	Pack
---------	-------------	------------------	------

**RCBO**

6730 78	Single pole + Neutral - 30 mA, 16 A - 230 VA 2 module	8924	1/1
---------	--	------	-----

**Accessories**

6730 60	Cable outlet - 8 mm 1 module	258	20/200
6730 61	Blanking plate - 1 module	52	20/200
6730 62	Blanking plate - 2 module	58	10/100
0802 90	Panel mounting support 1 module	230	10/200
0802 91	Panel mounting support 2 module	238	10/200

**Myrius antibacterial switches & accessories - white**

6730 84	6 A switch 1 W - 1 module	196	20/200
6730 85	6 A switch 2 W - 1 module	264	20/200
6730 86	6 A bell push - 1 module	292	20/200
6730 89	16 A switch 1 way - 1 module	350	20/200
6730 90	16 A switch 2 way - 1 module	406	20/200
6730 92	Fan regulator 120 W - 2 module	1258	1/10/100
6730 93	Multistandard socket - 2 module	440	10/100
6730 94	6 A 5 pin universal socket 2 module	382	20/200
6730 95	6/16 A socket - 3 module	622	5/50
0787 00	Equipotential socket 1 module antibacterial	1726	1/10
6730 98	T.V. socket - 1 module	260	20/200
6730 99	RJ -11 telephone socket - 1 module	260	20/200
6730 81	RJ-45 Cat 6 UTP - 1 module	906	20/200
6730 82	Blanking plate - 1 module	46	20/200
6732 45	1 module plate + frame 1 module	186	20/200
6732 46	2 module plate + frame 2 module	210	20/200
6732 47	3 module plate + frame 3 module	234	10/100
6732 48	4 module plate + frame 4 module	254	10/100
6732 49	8 module plate + frame (horizontal) 8 module	486	5/50
6732 50	8 module plate + frame (4x2) 8 module	608	5/25
6732 52	16 module plate + frame 16 module	850	1/10

\* MRP - Maximum Retail Price Inclusive of all taxes including GST.

# Myrius™

## More is on.

### ANTI-BACTERIAL

### MORE FOR YOUR WELLNESS



Myrius anti-bacterial products offer anti-bacterial protection. The composition of the product contain Ag+ ions that eliminates the proliferation of bacteria on contact with the surface of the product. It has a smooth and straight design that facilitates in reducing the dust accumulation. It is self disinfecting throughout its lifespan.

- Extremely useful in agri-food premises, healthcare environments & premises with high risk in terms of people's fragility.
- Special protection for the health and hygiene market in the form of an equipotential socket for earthing devices, application to connection of hospital beds and trolleys to medical apparatus to avoid all risk of potential difference during the medical care.



Scan to know more about the product.



## Myrius™ mechanisms - black

Cat.Nos	Description	MRP* ₹ / Unit	Pack
---------	-------------	------------------	------

### Switches – 6 A - 230 VA

6731 00	6 A switch 1 W 1 module	174	20/200
6731 01	6 A switch 2 W 1 module	250	20/200
6731 02	6 A switch 1 W with indicator - 1 module	274	20/200
6731 03	6 A switch 1 W with "Light" marking 1 module	210	20/200
6731 04	6 A switch 1 W with "Fan" marking 1 module	210	20/200

### Switches – 10 A - 230 VA

6731 05	10 A switch 1 W 2 module	310	10/100
6731 06	10 A switch 2 W 2 module	332	10/100
6731 17	10 A intermediate switch 2 module	1918	10/100
6731 07	10 A switch 1 W with indicator - 2 module	358	10/100

### Switches – 16 A - 230 VA

6731 08	16 A switch 1 way 1 module	324	20/200
6731 09	16 A switch 2 way 1 module	390	20/200
6731 10	16 A switch 1 way with indicator - 1 module	406	20/200

### Switches – 20 A - 230 VA

6731 11	20 A 1 W switch 1 module	434	20/200
6731 12	20 A DP 1 W switch 2 module	680	10/100
6731 13	20 A DP 1 W switch with indicator - 2 module	720	10/100
6731 14	20 A 2 W switch 2 module	744	10/100

### Switches – 25 A - 230 VA

6731 15	25 A SP 1 W switch with indicator - 1 module	500	20/200
---------	--	-----	--------



6731 01



6731 02



6731 05



6731 10



6731 12



6731 15

## Myrius™ mechanisms - black

Cat.Nos	Description	MRP* ₹ / Unit	Pack
---------	-------------	------------------	------

### Switches – 32 A - 230 VA

6731 16	32 A DP switch with indicator - 2 module	1146	10/100
---------	--	------	--------

### Push buttons

6731 18	6 A push button SP 1 module	288	20/200
6731 19	6 A push button SP with indicator - 1 module	364	20/200
6731 20	6 A bell push - 1 module	274	20/200
6731 21	6 A bell push with indicator - 1 module	364	20/200
6731 22	6 A bell push 2 module	418	10/100
6731 23	6 A bell push with indicator - 2 module	500	10/100

### Accessories for switches with indicator

6732 44	Lamp for switches / push buttons	52	5/50
---------	-------------------------------------	----	------

### Socket - black

6731 41	6/16 A 2 pin Euro US socket - 1 module	388	20/200
6731 42	16 A 3 pin switched socket - 3 module	1256	5/50
6731 43	Multistandard socket 6/10/13 A - 2/3 pin for 250 V AC 15 A for 127 V type - 2 pin 2 module	428	10/100
6731 44	6 A 5 Pin with universal socket 2 module	346	20/200
6731 83	6/16 A socket 3 module	590	5/50
6731 45	6/16 A socket 2 module	502	10/100
6731 47	25 A socket - 2 module	614	10/100

### Socket - red

6730 48	16 A switched socket 3 module	1114	5/50
---------	----------------------------------	------	------

### Dimmers & regulators

6731 24	Rotary dimmer 400 W 1 module	1216	1/5/50
6731 25	Rotary dimmer 650 W 3 module	2572	1/10
6731 27	Fan step regulator 100 W 1 module	950	1/5/50
6731 29	Fan step regulator 100 W 2 module	1078	1/10/100
6731 28	Fan step regulator 120 W 2 module	1184	1/10/100
6731 77	Fan step regulator - 2 module for energy saving fans	1142	1/10/100



6731 21



6731 22



6731 41



6731 42



6731 44



6730 48



6731 25



6731 27

\* MRP - Maximum Retail Price Inclusive of all taxes including GST.

**Bold Cat.Nos** are products normally available with Legrand (India) Stockists. **Cat.Nos that are not bold** - delivery within 4 - 8 weeks from the date of order. **Bold packing quantity** is our mandatory packing. Orders to be placed by Legrand (India) Stockist in multiples of the same.

## Myrius™ mechanisms - black



6731 36



6731 33



6731 34



6731 40



6731 50



6731 52

Cat.Nos	Description	MRP* ₹ / Unit	Pack
---------	-------------	------------------	------

### Skirting light

6731 36	Skirting light with white LED - 3 module	942	1/5/25
---------	--	-----	--------

### Bell indicator

6731 33	Bell Indicator- 240 VA 1 module	1356	20/200
---------	---------------------------------	------	--------

### Buzzer

6731 34	Buzzer - 230 VA sound level 72dB at 1 meter distance 1 module	1316	20/200
---------	---	------	--------

### Remote unit

6731 73	Remote control switch 4 module	9486	1/5/20
---------	--------------------------------	------	--------

### Hospitality functions Key FOB switch

6731 37	15 A key card switch with timedelay 30 sec. monobloc with plate - 2 M	4406	1/10
6732 67	15 A key card switch monobloc with new plate - 2 M Black	4846	1/10
6730 38	Only key fob for switch Cat.No 6731 37 & 6732 67	180	1/10/100

### "Do Not Distrub" and MMR control unit

6731 39	External unit - 1+1 module	1874	10/100
6731 40	Internal unit - 1+1 module	1252	10/100

### Shaver socket

6731 49	Shaver socket 220/240 V - 50/60 Hz monobloc with plate - 4 M	5286	1/5/20
6731 79	Shaver socket 230 V / 120 - 230 V monobloc with new plate - 4 M Black	5564	1/5

### TV socket

6731 50	TV socket - 1 module	260	20/200
---------	----------------------	-----	--------

### Data & voice

6731 52	RJ-11 telephone socket with transparent shutter 1 module	250	20/200
6731 53	RJ-11 double telephone socket with shutter 1 module	378	20/200

### Data & voice

6731 54	UTP cat 5e RJ 45 information outlets 1 module	544	20/200
6731 55	UTP cat 6 - 1 module	830	20/200
6731 56	UTP cat 6 - 2 module	838	10/100

\* MRP - Maximum Retail Price Inclusive of all taxes including GST.  
\* To be Introduced Shortly

## Myrius™ mechanisms - black

Cat.Nos	Description	MRP* ₹ / Unit	Pack
---------	-------------	------------------	------

### USB chargers (IS13252 (Part 1) / IEC 60950-1)

6731 72	#USB Charger 1M 1500mA	1678	10/100
6732 78	Double USB Charger 2M 2400mA	2348	1/10/100

### Connectors and controllers Audio & video connector

6731 57	3 x female RCA -1 module	3292	1/10
6731 58	3 pole XLR sockets 2 module	3106	10/100

### Sound

6731 63	Suitable for 8 Ohms, 8 Ohms, 3 Watts (RNS) speaker - 2 module	1582	1/10/100
---------	---	------	----------

### Protectors and accessories Motor starter

6731 30	16 A motor starter- 2 module	784	1/10/100
6731 31	25 A motor starter- 2 module	802	1/10/100

### Modular MCB (IS : 60898-1:2002)

6731 64	16A MCB SP 1M C curve	474	1/10/100
6731 65	20A MCB SP 1M C curve	474	1/10/100

### Accessories

6731 60	Cable outlet - 8mm 1 module	310	20/200
6731 61	Blanking plate-1 module	56	20/200

### Plastic plates White plates with frame

6732 01	1 Module plate + Frame	176	20/200
6732 02	2 Module plate + Frame	184	20/200
6732 03	3 Module plate + Frame	196	10/100
6732 04	4 Module plate + Frame	218	10/100
6732 06	6 Module plate + Frame	384	5/50
6732 08	8 Module plate + Frame (horizontal)	418	5/50
6732 09	8 Module plate + Frame (4x2)	526	5/25
6732 12	12 Module plate + Frame	634	1/10
6732 16	16 Module plate + Frame	736	1/10
6732 18	18 Module plate + Frame	848	1/10



6731 63



6732 01



6732 03

Bold Cat.Nos are products normally available with Legrand (India) Stockists. Cat.Nos that are not bold - delivery within 4 - 8 weeks from the date of order. Bold packing quantity is our mandatory packing. Orders to be placed by Legrand (India) Stockist in multiples of the same.



## Myrius™ plastic plates



Cat.Nos	Description	MRP* ₹ / Unit	Pack
<b>New white plates with frame*</b>			
6732 11	1 Module plate + Frame	178	20/200
6732 42	2 Module plate + Frame	194	20/200
6732 13	3 Module plate + Frame	208	10/100
6732 14	4 Module plate + Frame	222	10/100
6732 66	6 Module plate + Frame	432	5/50
6732 68	8 Module plate + Frame (Horizontal)	460	5/50
6732 69	8 Module plate + Frame (4x2)	578	5/25
6732 62	12 Module plate + Frame	702	1/10
6732 56	16 Module plate + Frame	820	1/10
6732 58	18 Module plate + Frame	940	1/10

### Black plates with frame

6732 21	1 Module plate + Frame	298	20/200
6732 22	2 Module plate + Frame	322	20/200
6732 23	3 Module plate + Frame	340	10/100
6732 24	4 Module plate + Frame	382	10/100
6732 26	6 Module plate + Frame	660	5/50
6732 28	8 Module plate + Frame (Horizontal)	734	5/50
6732 29	8 Module plate + Frame (4 x 2)	906	5/25
6732 32	12 Module plate + Frame	1082	1/10
6732 36	16 Module plate + Frame	1270	1/10
6732 38	18 Module plate + Frame	1438	1/10

### New black plates with frame\*

6732 31	1 Module plate + Frame	338	20/200
6732 82	2 Module plate + Frame	376	20/200
6732 33	3 Module plate + Frame	398	10/100
6732 34	4 Module plate + Frame	436	10/100
6732 86	6 Module plate + Frame	764	5/50
6732 88	8 Module plate + Frame (Horizontal)	834	5/50
6732 89	8 Module plate + Frame (4 x 2)	1044	5/25
6732 92	12 Module plate + Frame	1252	1/10
6732 96	16 Module plate + Frame	1460	1/10
6732 98	18 Module plate + Frame	1648	1/10

### Mounting boxes

#### Flush mounting boxes

6890 07	Flush box - 1/2 module	118	40
6890 08	Flush box - 3 module	118	40
6890 09	Flush box - 4 module	160	40

\* MRP - Maximum Retail Price Inclusive of all taxes including GST.  
# The new plate range will be introduced shortly.

Cat.Nos	Description	MRP* ₹ / Unit	Pack
<b>Flush mounting boxes</b>			
6890 10	Flush box - 6 module	250	40
6890 42	Flush box - 8 module	292	40
6890 31	Flush box - 8 module (2 row x 4)	290	20
6890 11	Flush box - 12/16 (2 row x 6) module (metal box)	438	10
6890 12	Flush box - 18 module (metal box)	554	10



6890 11

#### Surface mounting boxes

6733 02	Surface box - 1/2 module	76	10/50
6733 03	Surface box - 3 module	90	5/35
6733 04	Surface box - 4 module	104	5/25
6733 06	Surface box - 6 module	134	1/10
6733 08	Surface box - 8 module	202	1/5
6733 05	Surface box - 8 (2 row x 4) module	194	1/5

#### Metal surface boxes

6890 21	Metal surface box - 12/16 (2 row x 6) module	482	1/6
6890 22	Metal surface box - 18 module	508	1/4

## Myrius™ More is on.

### Guarantee

- The Company, at its discretion, will replace products if they have any manufacturing defect within 10 years for switches (without LED lamp) and power sockets. For all other Myrius™ wiring accessories the guarantee will be 2 years.
- The above guarantee is applicable when the devices are used in Legrand metal flush boxes. Otherwise the guarantee period will be reduced by 50%.
- The guarantee is only applicable when the products are installed as per the Company's instructions and not tampered in any manner.
- The guarantee states the Company's entire liability. It does not extend to cover consequential loss or damage or installation costs arising from defective products.

\* MRP - Maximum Retail Price Inclusive of all taxes including GST.  
# The new plate range will be introduced shortly.



# Mylinc™

A little touch of genius

## A LITTLE TOUCH OF GENIUS

Mylinc™ is a complete range of modular wiring accessories. Switches and sockets designed and made in India, keeping everyone's requirements in mind. Whether it's safety, reliability, convenience or beauty; Mylinc™ is the smart option in modular switch design.



Remote control unit for Light and Fan

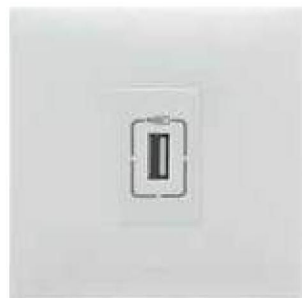

USB Charger



8 Step Fan Regulator



Modular MCB



Champagne



Silver Alu



Scan to know more about the product.



**Dark Bronze**



**Matt Grey**



**Pearl White**

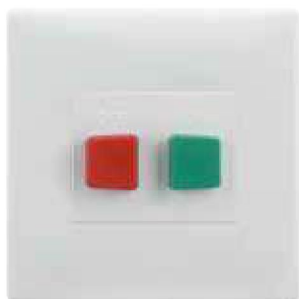

**Motor Starter**



**Skirting Light 2 M**



**Switch 25 A with indicator**

# Mylinc™

A little touch of genius

## A LITTLE TOUCH OF GENIUS



Screwless finish & rounded corners that add beauty to any home



Linc-Loc™ intelligent design prevents wrong fitting, misaligned switches and sockets



Laser marking safeguards against fakes



Safety feature for mishap-proof use



Indicators for correct orientation



Front Removal



Stripping Template



ISI marking



CE marking



Finger-proof terminals for IP 20 protection against accidental contact

**1 lac operations**

with a guarantee of 100,000 operations, assuming an average switch is operated 10 times a day, this product is dependable for 27 years.



## Mylic™ mechanisms

Cat.Nos	Description	MRP* ₹ / Unit	Pack
---------	-------------	------------------	------

### Switches and accessories

#### Switches 6 A - 250 V AC

6755 01	6 A one-way SP switch - <b>1 module</b>	96	20/200
6755 02	6 A two-way SP switch - <b>1 module</b>	168	20/200
6755 03	6 A one-way SP switch with indicator - <b>1 module</b>	190	20/200

#### Switches 16 A - 250 V AC

6755 11	16 A one-way SP switch - <b>1 module</b>	188	20/200
6755 12	16 A two-way SP switch - <b>1 module</b>	236	20/200
6755 13	16 A one-way SP switch with indicator - <b>1 module</b>	244	20/200

#### Switch 25 A - 250 V AC

6759 68	Switch 25 A with indicator - <b>1 module</b>	288	10/100
---------	--	-----	--------

#### Switches 32 A - 250 V AC

6755 26	32 A one-way double pole switch with indicator - <b>2 module</b>	556	10/100
---------	--	-----	--------

#### Push buttons 6 A - 250 V AC

6755 04	6 A one-way SP bell push - <b>1 module</b>	174	20/200
6755 06	6 A one-way SP bell push with indicator - <b>2 module</b>	344	10/100

#### Bell call indicator & register - 6 A - 250 V AC

6755 07	Bell call Indicator with register - 6 A - one-way - SP - <b>1 module</b>	924	20/200
---------	--	-----	--------

#### Lighting modules

6755 95	Indicator light red - <b>1 module</b>	214	20/200
6755 96	Indicator light orange - <b>1 module</b>	214	20/200
6755 97	Skirting light with white LED - <b>3 module</b>	692	1/5/25
6759 76	Skirting light with white LED - <b>2 module</b>	466	5/50

#### Dimmers and fan regulators

6755 35	Rotative dimmer 60 - 250 W for light - <b>2 module</b>	580	1/10/100
6755 33	Mylic dimmer 400 W for light - <b>1 module</b>	738	1/5/50
6759 64	Fan regulator 100 W with 360° rotation - <b>2 module</b>	654	10/100
6755 30	Fan regulator 100 W, Humfree, 0-4 steps - <b>2 module</b>	706	1/10/100
6755 31	Fan regulator 100 W, Humfree, 0-4 steps - <b>1 module</b>	530	1/5/50
6759 77	Fan regulator 8 steps - <b>2 module</b>	706	1/10/100

## Mylic™ mechanisms

Cat.Nos	Description	MRP* ₹ / Unit	Pack
---------	-------------	------------------	------

### Buzzer

6755 40	Mylic buzzer	620	20/200
---------	--------------	-----	--------

### Remote unit

6759 75	Remote control unit with remote for 4 switch & fan load 4 m	3224	1/5/20
---------	---	------	--------

### DND & MMR

#### Indicator lamp

6755 56	DND & MMR external unit with bellpush 3 m	326	10/50
6759 69	DND & MMR external unit with bellpush 1+1 - 2 m	326	10/100
6755 57	Mylic internal control unit for DND & MMR	272	10/100

### Hotel key fob switch

6755 60	Hotel key fob switch - monobloc	2996	1/10
6730 38	Only key fob for 6755 60	180	1/10

### Energy sockets / power unit

#### Energy sockets

6755 50	6 A - 2/3 pin combine - <b>2 module</b>	194	10/100
6755 55	6/16 A - 3 pin combine - <b>2 module</b>	326	10/100
6755 51	6 A - 3 pin - <b>2 module</b>	216	10/100
6755 52	Universal socket 6 A - 2/3 pin combine - <b>2 module</b>	246	10/100
6755 53	Euro US socket 6/16 A - 2 pin, <b>1 module</b>	306	20/200
6755 54	6/10/13 A - multistandard socket - <b>2 Module</b>	324	10/100

#### Power unit

6755 58	Power unit for 2 ton A.C and 3.5 KW geyser - <b>4 module</b>	1134	5/25
---------	--	------	------

### Motor starter

6759 65	Motor starter 16 A 2 m	530	1/10/100
---------	------------------------	-----	----------

### Modular MCB (IS : 60898-1:2002)

6759 74	Modular SP MCB 16 A 1 m	376	1/10/100
6756 40	Modular SP MCB 20 A 1 m	376	1/10/100
6756 41	Modular SP MCB 25 A 1 m	376	1/10/100
6756 42	Modular SP MCB 32 A 1 m	376	1/10/100

### Low voltage sockets / TV socket and RJ11 telephone socket / accessories

6755 46	TV socket <b>1 module</b>	174	20/200
6755 41	RJ 11 telephone socket <b>1 module</b>	162	20/200
6755 44	Double RJ 11 telephone socket <b>1 module</b>	274	20/200
6759 66	RJ45 socket cat 5e with shutter - <b>1 module</b>	444	20/200
6759 67	RJ45 socket cat 6 with shutter - <b>1 module</b>	618	20/200

\* MRP - Maximum Retail Price Inclusive of all taxes including GST.

Bold Cat.Nos are products normally available with Legrand (India) Stockists. Cat.Nos that are not bold - delivery within 4 - 8 weeks from the date of order. Bold packing quantity is our mandatory packing. Orders to be placed by Legrand (India) Stockist in multiples of the same.

## Mylic™ mechanisms

Cat.Nos	Description	MRP* ₹ / Unit	Pack
---------	-------------	------------------	------

### USB chargers (IS13252(Part 1) / IEC 60950-1)

6759 71	USB charger - <b>1 module</b>	904	10/100
<b>6758 20*</b>	USB charger <b>1M 1500MA</b>	990	10/100
6759 72	Double USB charger - <b>2 module</b>	1490	10/100

### Accessories

<b>6755 91</b>	Cable outlet - <b>1 module</b>	150	<b>20/200</b>
<b>6755 90</b>	Blanking plate 0.8 mm - <b>1 module</b>	42	<b>20/200</b>
6755 92	Spare 12 screws with nuts	52	<b>20/200</b>

### Mylic™ plates

#### Modular white plates with frame

<b>6755 61</b>	1 module plate - white	114	<b>20/200</b>
<b>6755 62</b>	2 modules plate - white	114	<b>20/200</b>
<b>6755 63</b>	3 modules plate - white	152	<b>10/100</b>
<b>6755 64</b>	4 modules plate - white	174	<b>10/100</b>
<b>6755 66</b>	6 modules plate - white	216	<b>5/50</b>
<b>6755 67</b>	8 modules horizontal - white	276	<b>5/50</b>
<b>6755 68</b>	4x2 modules plate - white	282	<b>5/25</b>
6755 69	9 modules plate- white	330	<b>5/50</b>
6755 72	12 modules plate - white	406	<b>10</b>
6755 73	16 modules plate - white	470	<b>10</b>
6755 78	18 modules plate - white	630	<b>10</b>

## Mylic™ mechanism matt grey

### Switches and accessories

#### Switches 6 A - 250 V AC

6763 01	6 A one-way SP switch - <b>1 module</b>	112	<b>20/200</b>
6763 02	6 A two-way SP switch - <b>1 module</b>	182	<b>20/200</b>
6763 03	6 A one-way SP switch with indicator - <b>1 module</b>	214	<b>20/200</b>

#### Switches 16 A - 250 V AC

6763 11	16 A one-way SP switch <b>1 module</b>	206	<b>20/200</b>
6763 12	16 A two-way SP switch <b>1 module</b>	256	<b>20/200</b>
6763 13	16 A one-way SP switch with indicator <b>1 module</b>	274	<b>20/200</b>

#### Switch 25 A - 250V AC

6763 41	Switch 25 A with indicator - <b>1 module</b>	318	<b>10/100</b>
---------	---	-----	---------------

#### Switches 32 A - 250V AC

6763 26	32 A one-way double pole switch with indicator - <b>2 module</b>	622	<b>20/200</b>
---------	--	-----	---------------

#### Push buttons 6 A - 250 V AC

6763 04	6 A one-way SP bell push <b>1 module</b>	184	<b>20/200</b>
6763 06	6 A one-way SP bell push with indicator <b>2 module</b>	378	<b>10/100</b>

\* MRP - Maximum Retail Price Inclusive of all taxes including GST.  
\* To be Introduced Shortly

## Mylic™ mechanism matt grey

Cat.Nos	Description	MRP* ₹ / Unit	Pack
---------	-------------	------------------	------

### Bell call indicator & register - 6 A - 250 V AC

6763 07	Bell call indicator with register - 6 A - one way <b>1 module</b>	1018	<b>20/200</b>
---------	---	------	---------------

### Lighting modules

6763 14	Indicator light red <b>1 module</b>	234	<b>20/200</b>
6763 15	Indicator light orange <b>1 module</b>	234	<b>20/200</b>
6763 16	Skirting light with white LED - <b>3 module</b>	760	1/5/25
6763 10	Skirting light with white LED - <b>2 module</b>	516	5/50

### Dimmers and fan regulators

6763 17	Rotative dimmer 60 - 250 W for light <b>2 module</b>	638	1/10/100
6763 18	Rotative dimmer 60 - 400 W <b>1 module</b>	814	1/5/50
6763 37	Fan regulator 100 W, with 360° rotation <b>2 module</b>	720	10/100
6763 19	Fan regulator 4 step <b>2 module</b>	776	1/10/100
6763 20	Fan regulator 4 step <b>1 module</b>	580	1/5/50
6763 08	Fan regulator 8 step <b>2 module</b>	772	1/10/100

### Buzzer

6763 21	Mylic buzzer	678	<b>20/200</b>
---------	--------------	-----	---------------

### Remote unit

6763 47	Remote control unit with remote for 4 switch & fan load 4 m	3548	1/5/20
---------	---	------	--------

### DND & MMR

#### Indicator lamp

6763 42	DND & MMR external unit with bellpush 1+1	358	<b>10/100</b>
6763 23	Mylic internal control unit for DND & MMR	300	<b>10/100</b>

### Hotel key fob switch

6730 38	Only key fob for 6755 60	180	1/10
6763 24	Hotel key fob switch monobloc	3292	1/10

### Energy sockets / power unit

#### Energy sockets

6763 25	6 A - 2/3 pin combined	220	<b>10/100</b>
6763 05	6/16A - 3 pin Combined <b>2 module</b>	350	<b>10/100</b>
6763 27	6 A - 3 pin - <b>2 module</b>	236	<b>10/100</b>
6763 28	Universal socket 6A-2/3 pin combined <b>2 module</b>	272	<b>10/100</b>

Bold Cat.Nos are products normally available with Legrand (India) Stockists.  
Cat.Nos that are not bold - delivery within 4 - 8 weeks from the date of order.  
Bold packing quantity is our mandatory packing. Orders to be placed by  
Legrand (India) Stockist in multiples of the same.



## Mylic™ mechanism matt grey

Cat.Nos	Description	MRP* ₹ / Unit	Pack
---------	-------------	------------------	------

### Energy sockets / power unit

#### Energy sockets

6763 29	Euro US socket 6/16A - 2 pin <b>1 module</b>	338	<b>20/200</b>
6763 30	6/10/13 A - Multistandard socket <b>2 module</b>	350	<b>10/100</b>

#### Power unit

6763 31	Power unit for 2 ton A.C and 3.5 KW geyser - <b>4 module</b>	1286	5/25
---------	--	------	------

#### Motor starter

6763 38	Motor starter 16 A 2 m	586	1/10/100
---------	------------------------	-----	----------

#### Modular MCB (IS : 60898-1:2002)

6763 46	Modular SP MCB 16 A 1 m	420	1/10/100
---------	----------------------------	-----	----------

### Low voltage sockets / TV socket and RJ11 telephone socket / accessories

#### Sockets

6763 32	TV socket - <b>1 module</b>	184	<b>20/200</b>
6763 33	RJ 11 telephone <b>1 module</b>	178	<b>20/200</b>
6763 34	Double RJ 11 telephone socket <b>1 module</b>	296	<b>20/200</b>
6763 39	RJ 45 socket cat 5e with shutter <b>1 module</b>	480	<b>20/200</b>
6763 40	RJ 45 socket cat 6 with shutter <b>1 module</b>	670	<b>20/200</b>

#### USB chargers (IS13252(Part 1) / IEC 60950-1)

6763 43	USB charger <b>1 module</b>	994	<b>10/100</b>
6758 21*	USB charger <b>1M 1500MA</b>	1086	<b>10/100</b>
6763 44	Double USB charger <b>2 module</b>	1642	1/10/100

#### Accessories

6763 48	Cable outlet <b>1 module</b>	170	<b>20/200</b>
6763 49	Blanking plate 0.8 mm <b>1 module</b>	46	<b>20/200</b>

### Mylic™ plates

#### Modular Matt Grey plates with frame

6763 50	Matt grey plate 1 m	148	<b>20/200</b>
6763 51	Matt grey plate 2 m	148	<b>20/200</b>
6763 52	Matt grey plate 3 m	206	<b>10/100</b>
6763 53	Matt grey plate 4 m	218	<b>10/100</b>
6763 54	Matt grey plate 6 m	276	<b>5/50</b>
6763 55	Matt grey plate 8 m horizontal	364	<b>5/50</b>
6763 56	Matt grey plate 4x2 m	364	<b>5/25</b>
6763 57	Matt grey 9 m	428	<b>5/50</b>
6763 58	Matt grey plate 12 m	522	<b>10</b>
6763 59	Matt grey plate 18 m	826	<b>10</b>

## Modular colour plates with frame

Cat.Nos	Description	MRP* ₹ / Unit	Pack
---------	-------------	------------------	------

### Pearl white cover plates

6763 60	Pearl white plate 1 m	138	<b>10/100</b>
6763 61	Pearl white plate 2 m	138	<b>10/100</b>
6763 62	Pearl white plate 3 m	186	<b>10/100</b>
6763 63	Pearl white plate 4 m	200	<b>10/100</b>
6763 64	Pearl white plate 6 m	262	<b>5/50</b>
6763 65	Pearl white 8 m plate horizontal	334	<b>5/50</b>
6763 66	Pearl white plate 4x2 m	338	<b>5/25</b>
6763 67	Pearl white plate 9 m	396	<b>5/50</b>
6763 68	Pearl white plate 12 m	482	<b>5/25</b>
6763 69	Pearl white plate 18 m	756	<b>5/25</b>

### Champagne cover plates

6763 70	Champagne plate 1 m	138	<b>10/100</b>
6763 71	Champagne plate 2 m	138	<b>10/100</b>
6763 72	Champagne plate 3 m	186	<b>10/100</b>
6763 73	Champagne plate 4 m	200	<b>10/100</b>
6763 74	Champagne plate 6 m	262	<b>5/50</b>
6763 75	Champagne plate 8 m horizontal	334	<b>5/50</b>
6763 76	Champagne plate 4x2 m	338	<b>5/25</b>
6763 77	Champagne plate 9 m	396	<b>5/50</b>
6763 78	Champagne plate 12 m	482	<b>5/25</b>
6763 79	Champagne plate 18 m	756	<b>5/25</b>

### Silver alu cover plates

6763 80	Silver alu plate 1 m	138	<b>10/100</b>
6763 81	Silver alu plate 2 m	138	<b>10/100</b>
6763 82	Silver alu plate 3 m	186	<b>10/100</b>
6763 83	Silver alu plate 4 m	200	<b>10/100</b>
6763 84	Silver alu plate 6 m	262	<b>5/50</b>
6763 85	Silver alu plate 8 m horizontal	334	<b>5/50</b>
6763 86	Silver alu plate 4x2 m	338	<b>5/25</b>
6763 87	Silver alu plate 9 m	396	<b>5/50</b>
6763 88	Silver alu plate 12 m	482	<b>5/25</b>
6763 89	Silver alu plate 18 m	756	<b>5/25</b>

### Dark bronze cover plates

6763 90	Dark bronze plate 1 m	138	<b>10/100</b>
6763 91	Dark bronze plate 2 m	138	<b>10/100</b>
6763 92	Dark bronze plate 3 m	186	<b>10/100</b>
6763 93	Dark bronze plate 4 m	200	<b>10/100</b>
6763 94	Dark bronze plate 6 m	262	<b>5/50</b>
6763 95	Dark bronze plate 8 m horizontal	334	<b>5/50</b>
6763 96	Dark bronze plate 4x2 m	338	<b>5/25</b>
6763 97	Dark bronze plate 9 m	396	<b>5/50</b>
6763 98	Dark bronze plate 12 m	482	<b>5/25</b>
6763 99	Dark bronze plate 18 m	756	<b>5/25</b>

\* MRP - Maximum Retail Price Inclusive of all taxes including GST.  
\* To be Introduced Shortly

Bold Cat.Nos are products normally available with Legrand (India) Stockists.  
Cat.Nos that are not bold - delivery within 4 - 8 weeks from the date of order.  
Bold packing quantity is our mandatory packing. Orders to be placed by  
Legrand (India) Stockist in multiples of the same.



## Mylinc™ boxes

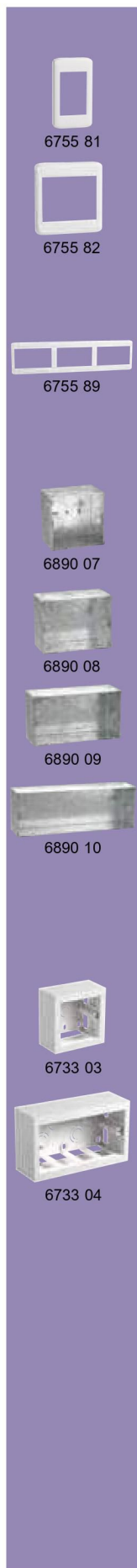

Cat.Nos	Description	MRP* ₹ / Unit	Pack
---------	-------------	---------------------	------

### Modular white surrounds

6755 81	1 module	44	20/200
6755 82	2 modules	68	20/200
6755 83	3 modules	68	10/100
6755 84	4 modules	110	10/100
6755 86	6 modules	156	10/100
6755 89	(2 column x 3) 9 modules (3 column x 3)	272	10/100

### Metal flush boxes

6890 07	Flush box - 1/2 modules	118	40
6890 08	Flush box - 3 modules	118	40
6890 09	Flush box - 4 modules	160	40
6890 10	Flush box - 6 modules	250	40
6890 42	Flush box - 8 modules	292	40
6890 31	Flush box - 4 x 2 modules	290	20
6890 29	Flush box - 9 modules	342	20
6890 11	Flush box - 12 modules	438	10
6890 13	Flush box - 16 modules	500	10
6890 12	Flush box - 18 modules	554	10

### Plastic surface boxes

6733 02	Surface box-1/2 modules	76	10/50
6733 03	Surface box-3 modules	90	5/35
6733 04	Surface box-4 modules	104	5/25
6733 06	Surface box-6 modules	134	1/10
6733 08	Surface box-8 modules	202	1/5
6733 05	Surface box-4 x 2 modules	194	1/5
6740 99	Surface box-9 modules	228	1/5

### Metal surface boxes

6890 21	Metal surface box- 12 modules (2 rows x 6)	482	1/6
6890 22	Metal surface box- 18 modules (3 rows x 6)	508	1/4

# Mylinc™

A little touch of genius

A LITTLE TOUCH OF GENIUS



## Guarantee

- The Company, at its discretion, will replace products if they have any manufacturing defect within 10 years for switches (without LED lamp) and power sockets. For all other **Mylinc™** wiring accessories the guarantee will be 2 years.
- The above guarantee is applicable when the devices are used in Legrand metal flush boxes. Otherwise the guarantee period will be reduced by 50%.
- The guarantee is only applicable when the products are installed as per the Company's instructions and not tampered in any manner.
- The guarantee states the Company's entire liability. It does not extend to cover consequential loss or damage or installation costs arising from defective products.

\* MRP - Maximum Retail Price Inclusive of all taxes including GST.

# Britzy™ SWITCHES

THE  
NO PROBLEM  
SWITCH



ORANGE  
CHROME

HERB  
BEIGE

URBAN  
BRONZE

WARM  
ORANGE  
SILVER

Now Available In  
4 New Colours



Scan to know more about  
the product.



# Britzy™ SWITCHES

## RANGE



Switch 6 A, 16 A



Switch 6 A two-way



Switch with indicator  
6 A, 16 A, 25 A



Bell push with  
indicator - 1 module



DP Switch 20 A, 32 A



Bell push with  
indicator - 2 module



DND internal unit



DND external unit



Universal socket  
6 A - 3 pin



Multi-standard socket



6/16 A socket



Euro US socket



Dimmer



Fan regulator  
1 module



Fan regulator  
2 module



USB charger  
1 module



USB charger  
2 module



RJ 45



RJ 11 Telephone socket



Double RJ 11  
Telephone socket



Bell call indicator



TV socket



Skirting light



Buzzer



Key card Switch 16 A



Flat indicator red



## Britzy™ switches

Cat.Nos	Description	MRP* ₹ / Unit	Pack
---------	-------------	------------------	------

### Switches

- All switches are ISI marked as per latest IS 3854:1997
- Finger-proof terminal for protection against accidental contact
- Laser marking for easy identification

6734 01	6 A Switch SP 1 way <b>1 module</b>	44	20/200
6734 02	6 A Switch SP 2 way <b>1 module</b>	90	20/200
6734 03	6 A Switch SP 1 way with indicator <b>1 module</b>	90	20/200
6734 11	16 A Switch SP 1 way <b>1 module</b>	128	20/200
6734 12	16 A Switch SP 2 way <b>1 module</b>	158	20/200
6734 13	16 A Switch SP 1 way with indicator <b>1 module</b>	142	20/200
6734 24	25 A Switch SP 1 way with indicator <b>1 module</b>	180	20/200
6734 25	20 A DP switch with indicator <b>2 modules</b>	200	10/100
6734 26	32 A DP switch with indicator <b>2 modules</b>	268	10/100

### Push buttons

6734 04	6 A Bell push with indicator <b>module 1</b>	104	20/200
6734 06	6 A Bell push with indicator <b>2 module</b>	164	10/100

### Sockets

- Confirming to IS 1293:2005
- Shuttered socket for child safety
- Shutter open only with phase and neutral insertion simultaneously

6734 52	6 A 3 pin universal socket <b>2 modules</b>	106	10/100
6734 53	Euro US socket <b>1 module</b>	90	20/200
6734 55	6/16 A socket 3 Pin <b>2 modules</b>	178	10/100
6734 56	25 A socket 3 Pin <b>2 modules</b>	200	10/100
6734 54	Multistandard socket <b>2 modules</b>	160	10/100

### Data & voice

6734 41	RJ11 telephone socket <b>1 module</b>	90	20/200
6734 44	Double RJ11 telephone socket <b>1 module</b>	134	20/200
6734 45	RJ45 Cat 6 computer socket <b>1 module</b>	270	20/200

- \* MRP - Maximum Retail Price Inclusive of all taxes including GST.
- To be Introduced Shortly



## Britzy™ switches

Cat.Nos	Description	MRP* ₹ / Unit	Pack
---------	-------------	------------------	------

### Television socket

6734 46	TV socket <b>1 module</b>	84	20/200
---------	---------------------------	----	--------

### Buzzer

6734 40	Buzzer 230 V <b>1 module</b>	280	20/200
---------	---------------------------------	-----	--------

### Dimmer & regulator

6734 31	Fan regulator 100 W <b>1 module</b>	382	5/50
6734 30	Fan regulator 100 W <b>2 modules</b>	482	10/100
6734 33	Light dimmer 400 W <b>1 module</b>	390	5/50

### Bell indicator

6734 07	Bell call indicator 1 module	532	20/200
---------	------------------------------	-----	--------

### Motor starter

6734 66	25 A Motor starter <b>2 modules</b>	442	10/100
---------	--	-----	--------

### Modular MCB (IS : 60898-1:2002)

6734 64	Modular SP MCB 16A	310	1/10/100
6734 61	Modular SP MCB 20A	310	1/10/100
6734 36	Modular SP MCB 25A	310	1/10/100
6734 37	Modular SP MCB 32A	310	1/10/100

### USB Charger

6734 34	USB charger <b>1M 1000mA</b>	650	10/100
6731 35*	USB charger <b>1M 1500mA</b>	812	10/100
6734 35	Double USB charger 2M 2000mA	1098	5/50

### Skirting light

6734 77	Skirting light <b>2 modules</b>	372	5/50
---------	---------------------------------	-----	------

### Indicator

6734 75	Flat indicator red <b>1 module</b>	96	20/200
---------	------------------------------------	----	--------

### Key card switch

6734 80	16 A Key card switch 2 modules	2010	1/10
6734 83	Keyfob credit card size for 6734 80	150	1/10

### Do Not Disturb indicator & internal control unit

6734 81	DND internal unit <b>2 modules</b>	212	10/100
6734 82	DND external unit <b>2 modules</b>	252	10/100

### Accessories

6734 71	Cable outlet <b>1 module</b>	74	20/200
6734 90	Blanking plate <b>1 module</b>	26	20/200
6734 72	Blanking plate <b>2 modules</b>	36	10/100

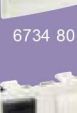
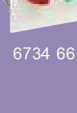

- Bold Cat.Nos are products normally available with Legrand (India) Stockists.
- Cat.Nos that are not bold - delivery within 4 - 8 weeks from the date of order.
- Bold packing quantity is our mandatory packing. Orders to be placed by Legrand (India) Stockist in multiples of the same.

## Britzy™ switches

Cat.Nos	Description	MRP* ₹ / Unit	Pack
---------	-------------	------------------	------

### White plates with frame

Sleek and curvy plates with elegant looks comes with sturdy support frame for solid strength

6734 91	Plate & frame 86 x 86 <b>1 module</b>	68	20/200
6734 92	Plate & frame 86 x 86 <b>2 modules</b>	68	20/200
<b>6734 93</b>	Plate & frame 121 x 86 <b>3 modules</b>	96	<b>10/100</b>
<b>6734 94</b>	Plate & frame 146 x 86 <b>4 modules</b>	102	<b>10/100</b>
<b>6734 96</b>	Plate & frame 224 x 86 <b>6 modules</b>	132	<b>5/50</b>
<b>6734 98</b>	Plate & frame 245 x 86 <b>8 modules</b>	170	<b>5/50</b>
<b>6734 95</b>	Plate & frame 146 x 172 <b>4 x 2 modules</b>	170	<b>5/25</b>
<b>6734 97</b>	Plate & frame 224 x 172 <b>12 modules</b>	246	10
6734 99	Plate & frame 245 x 172 <b>16 modules</b>	268	10
6735 00	Plate & frame 224 x 240 <b>18 modules</b>	328	10

### WARM ORANGE SILVER plates with frame

6735 01	Plate & frame 86 x 86 <b>1 module</b>	112	20/200
6735 02	Plate & frame 86 x 86 <b>2 modules</b>	112	20/200
6735 03	Plate & frame 121 x 86 <b>3 modules</b>	140	<b>10/100</b>
6735 04	Plate & frame 146 x 86 <b>4 modules</b>	168	<b>10/100</b>
6735 05	Plate & frame 224 x 86 <b>6 modules</b>	238	5/50
6735 06	Plate & frame 245 x 86 <b>8 modules</b>	252	5/50
6735 07	Plate & frame 146 x 172 <b>4 x 2 modules</b>	308	5/25
6735 08	Plate & frame 224 x 172 <b>12 modules</b>	428	10
6735 09	Plate & frame 245 x 172 <b>16 modules</b>	576	10
6735 10	Plate & frame 224 x 240 <b>18 modules</b>	662	10

### HERB BEIGE plates with frame

6735 11	Plate & frame 86 x 86 <b>1 module</b>	112	20/200
6735 12	Plate & frame 86 x 86 <b>2 modules</b>	112	20/200
6735 13	Plate & frame 121 x 86 <b>3 modules</b>	140	<b>10/100</b>
6735 14	Plate & frame 146 x 86 <b>4 modules</b>	168	<b>10/100</b>
6735 15	Plate & frame 224 x 86 <b>6 modules</b>	238	5/50
6735 16	Plate & frame 245 x 86 <b>8 modules</b>	252	5/50

\* MRP - Maximum Retail Price Inclusive of all taxes including GST.  
\* To be Introduced Shortly

## Britzy™ switches

Cat.Nos	Description	MRP* ₹ / Unit	Pack
---------	-------------	------------------	------

### NEW! HERB BEIGE plates with frame

6735 17	Plate & frame 146 x 172 <b>4 x 2 modules</b>	308	5/25
6735 18	Plate & frame 224 x 172 <b>12 modules</b>	428	10
6735 19	Plate & frame 245 x 172 <b>16 modules</b>	576	10
6735 20	Plate & frame 224 x 240 <b>18 modules</b>	662	10

### NEW! URBAN BRONZE plates with frame

6735 21	Plate & frame 86 x 86 <b>1 module</b>	112	20/200
6735 22	Plate & frame 86 x 86 <b>2 modules</b>	112	20/200
6735 23	Plate & frame 121 x 86 <b>3 modules</b>	140	<b>10/100</b>
6735 24	Plate & frame 146 x 86 <b>4 modules</b>	168	<b>10/100</b>
6735 25	Plate & frame 224 x 86 <b>6 modules</b>	238	5/50
6735 26	Plate & frame 245 x 86 <b>8 modules</b>	252	5/50
6735 27	Plate & frame 146 x 172 <b>4 x 2 modules</b>	308	5/25
6735 28	Plate & frame 224 x 172 <b>12 modules</b>	428	10
6735 29	Plate & frame 245 x 172 <b>16 modules</b>	576	10
6735 30	Plate & frame 224 x 240 <b>18 modules</b>	662	10

### NEW! ORANGE CHROME plates with frame

6735 31*	Plate & frame 86 x 86 <b>1 module</b>	112	20/200
6735 32*	Plate & frame 86 x 86 <b>2 modules</b>	112	20/200
6735 33*	Plate & frame 121 x 86 <b>3 modules</b>	140	<b>10/100</b>
6735 34*	Plate & frame 146 x 86 <b>4 modules</b>	168	<b>10/100</b>
6735 35*	Plate & frame 224 x 86 <b>6 modules</b>	238	5/50
6735 36*	Plate & frame 245 x 86 <b>8 modules</b>	252	<b>5/50</b>
6735 37*	Plate & frame 146 x 172 <b>4 x 2 modules</b>	308	5/25
6735 38*	Plate & frame 224 x 172 <b>12 modules</b>	428	10
6735 39*	Plate & frame 245 x 172 <b>16 modules</b>	576	10
6735 40*	Plate & frame 224 x 240 <b>18 modules</b>	662	10

Bold Cat.Nos are products normally available with Legrand (India) Stockists.  
Cat.Nos that are not bold - delivery within 4 - 8 weeks from the date of order.  
Bold packing quantity is our mandatory packing. Orders to be placed by Legrand (India) Stockist in multiples of the same.



## Britzy™ switches

Cat.Nos	Description	MRP* ₹ / Unit	Pack
---------	-------------	---------------------	------

### Flush mounting boxes - Metal

- Boxes are with top, bottom, side and back wall knockout for conduit entry from any direction
- Possible to break open knockout without any special tool

6890 60	Metal flush box 75.7 x 75.7 x 50.8 <b>1 &amp; 2 modules</b>	60	40
6890 61	Metal flush box 98.9 x 75.7 x 50.8 <b>3 modules</b>	82	40
6890 62	Metal flush box 136 x 75.7 x 50.8 <b>4 modules</b>	102	40
6890 63	Metal flush box 213.4 x 75.7 x 50.8 <b>6 modules</b>	156	40
6890 64	Metal flush box 136.6 x 136.8 x 61 <b>8 (2 rows x 4) modules</b>	200	20
6890 65	Metal flush box 231.2 x 75.7 x 50.8 <b>8 modules</b>	200	40
6890 66	Metal flush box 215 x 145.3 x 61.2 <b>12 (2 rows x 6) modules</b>	274	10
6890 67	Metal flush box 232.8 x 147.4 x 61.2 <b>16 (2 rows x 8) modules</b>	308	10
6890 68	Metal flush box 215 x 213.3 x 61.2 <b>18 modules</b>	354	10

### Surface mounting boxes - Plastic

6890 70	Plastic surface box 86 x 86 x 45 <b>1 &amp; 2 modules</b>	54	10/50
6890 71	Plastic surface box 121 x 86 x 45 <b>3 modules</b>	68	5/35
6890 72	Plastic surface box 146 x 86 x 45 <b>4 modules</b>	90	5/25
6890 73	Plastic surface box 224 x 86 x 45 <b>6 modules</b>	134	1/10
6890 74	Plastic surface box 146 x 172 x 45 <b>8 (2 rows x 4) modules</b>	188	2/10
6890 75	Plastic surface box 245.2 x 86 x 45 <b>8 modules</b>	188	1/10
6890 76	Plastic surface box 224 x 172 x 45 <b>12 (2 rows x 6) modules</b>	230	1/10
6890 77	Plastic surface box 245.2 x 172 x 45 <b>16 (2 rows x 8) modules</b>	266	1/10

### Surface mounting boxes - Metal

6890 78	Metal surface box <b>18 modules</b>	282	1/10
---------	--	-----	------

- \* MRP - Maximum Retail Price Inclusive of all taxes including GST.
- \* To be Introduced Shortly

# Britzy™ SWITCHES

## THE NO PROBLEM SWITCH



### Guarantee

- The Company, at its discretion, will replace products if they have any manufacturing defect within 10 years for switches (without LED lamp) and power sockets. For all other **Britzy™** wiring accessories the guarantee will be 2 years.
- The above guarantee is applicable when the devices are used in Legrand metal flush boxes. Otherwise the guarantee period will be reduced by 50%.
- The guarantee is only applicable when the products are installed as per the Company's instructions and not tampered in any manner.
- The guarantee states the Company's entire liability. It does not extend to cover consequential loss or damage or installation costs arising from defective products.



# POP-UP BOXES

Our sleek new ergonomically designed pop-up boxes provide real ease of use and rapid connection solutions for mobile applications such as PCs, mobile phones, audio and video systems.



## **SLEEK DESIGN**

Extra-slim format to blend discreetly into the office furniture or floor



Scan to know more about the product.



**SAFETY AND EASE OF USE**

Soft opening cover with damper and push & slide locking system



**ELEGANT FINISHES**

Aluminium, bronze, stainless steel, black or white - a perfect match for furniture and decor



**FUNCTIONALITY AND FLEXIBILITY**

Available in 3, 2x3, 4 and 2x4 modules for custom configuration or ready assembled with low and high current functions

## Heavy duty in-screed floor box for screed floors

Cat.Nos	Description	MRP* ₹ / Unit	Pack
---------	-------------	------------------	------

### Plates for metal in-screed floor boxes

0896 86	IP 66 plate (cover closed and plugs not connected) with central cable exit	73004	1
0896 87	IP 14 Cable exit accessory for IP66 cover plate Cat.No 0896 86 be used as a simple access to the floor void	39010	-

### Over floor trunking

Conform to Std EN 50085-2-2; For creating a link between trunking, column, mini-column, floor units or protecting cables on passageways Supplied with cover

0300 92	Over floor trunking 50 x 12 mm; length 2 m, supplied with cover; 3 Compartments;	496	54 <sup>(1)</sup>
0300 11	Flat angle/floor 50 x 12	196	10
0300 12	Cover joint/floor 50 x 12	250	10
0300 93	Over floor trunking 75 x 18 mm; length 2 m, supplied with cover; 3 compartments;	678	36 <sup>(1)</sup>
0300 18	Flat angle/floor 75 x 18	378	10
0300 19	Cover joint/floor 50 x 12	262	10
0328 00	Over floor trunking 92 x 20 mm; Length 2 m, supplied with cover; 4 Compartments, equipped with 2 adhesive strips for better floor fixing	1242	20 <sup>(1)</sup>
0328 07	End cap for floor duct 92 x 20	220	10
0328 03	Cover joint for floor duct 92 x 20	300	10
0328 02	Flat angle for floor duct 92 x 20	542	5

## Floor boxes 3 module for screed floor and raised floor

### Floor service outlet boxes - 3 modules

0896 44	Floor service outlet box - 3 modules Grey RAL 7031 To be equipped with Arteor Mechanism	1596	1
0896 49	Flush mounting box for concrete for Cat.No 0896 44	1066	1

### IP 66 Floor box - 4 module

Conform to EN 60670-1 and EN 60670-23 standards (when lid is closed) / IP55 (with cable exit accessory Cat.No 0880 62)

0880 61	IP66/IK09 screwed stainl. steel floor box (with removable lid); can be equipped with cable exit accessory Cat. No 0880 62	17412	1
0880 64	IP66/IK09 hinged cover stainl. steel floor box	20948	1

\* MRP - Maximum Retail Price Inclusive of all taxes including GST.  
(1) Price in Meters; No of meters in Pack, Standard length 2 meters to be ordered in multiple of 2 meters.

## Floor boxes 3 module for screed floor and raised floor

Cat.Nos	Description	MRP* ₹ / Unit	Pack
---------	-------------	------------------	------

### IP 66 Floor box - 4 module

Conform to EN 60670-1 and EN 60670-23 standards (when lid is closed) / IP55 (with cable exit accessory Cat.No 0880 62)

0880 69	Auto adjustable back box for installing IP66 floor boxes in concrete floors; supplied with cover; accepts conduit dia 20 mm; min screed height 65 mm	3344	1
0880 62	IP55 cable exit accessory	19216	1

## Floor access unit for raised floors

### IP 20 - IK 08

0893 07	Access master box floor box that can be used as a simple access to the floor void	7454	1
---------	---	------	---

## Pop-up type flush-mounting boxes for floor

### Pop-up boxes to be equipped

Equipped with "push and slide" locking system to avoid accidental opening by feet  
To be equipped with Arteor socket outlets  
For installation use the flush-mounting boxes for concrete floors or the kits for raised access floors

### 3 modules

0540 10	Matt aluminium finish	2512	1
0540 15	Brushed brass	3584	1
0540 20	Brushed Stainless steel finish	3630	1

### 4 modules

0540 11	Matt aluminium finish	3336	1
0540 16	Brushed brass	4250	1
0540 21	Brushed Stainless Steel finish	4598	1
0540 26	Matt black	4154	1
0540 31	Glossy white	4254	1

### 6 (2 x 3) modules

0540 12	Matt aluminium finish	5582	1
0540 17	Brushed brass	7700	1
0540 22	Brushed stainless steel finish	7984	1

### 8 (2 x 4) modules

0540 13	Matt aluminium finish	6912	1
0540 18	Brushed brass	9240	1
0540 23	Brushed stainless steel finish	9830	1
0540 28	Matt black	8904	1
0540 33	Glossy white	8956	1

### Retractable accessory for Pop Up

0540 34	RJ45 Cat 6 UTP retractable Kit - 1 module	3404	1
0540 35	RJ45 Cat 6 FTP retractable Kit - 1 module	4760	1
0540 36	USB/ Micro-USB Retractable Kit - 1 module	3224	1

Bold Cat.Nos are products normally available with Legrand (India) Stockists. Cat.Nos that are not bold - delivery within 4 - 8 weeks from the date of order. Bold packing quantity is our mandatory packing. Orders to be placed by Legrand (India) Stockist in multiples of the same.



## Pop-up type flush-mounting boxes for floor

Cat.Nos	Description	MRP* ₹ / Unit	Pack
---------	-------------	------------------	------

### Installation kits for raised access floors

Include an empty receptacle and fixing brackets for raised access floor tiles Compatible with:

- Cat. 6 data cabling
- Audio/video cabling

0540 05	3 modules	1124	1
0540 06	4 modules	1350	1
0540 07	6 (2 x 3) modules	1872	1
0540 08	8 (2 x 4) module	2308	1



0540 06

### For installation of pop-up floor boxes in concrete floors

Equipped with knockouts for ø 20 and ø 25 mm conduits

#### Metal flush-mounting boxes

0540 00	3 modules	306	1
0540 01	4 modules	406	1
0540 02	6 (2 x 3) modules	646	1
0540 03	8 (2 x 4) modules	808	1



0540 00

## Pop-up type flush-mounting boxes for furniture

### Pop-up boxes to be equipped

Slim design for perfect integration into the furniture  
To be equipped with Arteor socket outlets  
Supplied alongwith installation kits for table top

#### 4 modules

<b>6540 14</b>	Matt Aluminium	3266	1
6540 00	Matt steel finish	4364	1
6540 01	Glossy White	4038	1
6540 02	Matt Black	3864	1



6540 00

#### 8 (2 x 4) modules

<b>6540 15</b>	Matt Aluminium	6764	1
6540 03	Matt steel finish	9442	1
6540 04	Glossy White	8594	1
6540 05	Matt Black	8544	1

## Power & data desk grommets for workstation & meeting room table application

### Empty power & data desk grommets

To be equipped with Arteor socket outlets, Easily retro fitted into a 60 to 80 mm diameter hole in current office desks and workspace table tops (by replacing the desk grommet)  
Cover opens to 180° angle to prevent breaking

#### For one 2P+E socket

0540 70*	White RAL 9003, to be equipped with 1 socket	2368	1
0540 71*	Black RAL 9017, to be equipped with 1 socket	2200	1

0540 70  
+ 0540 60

#### For one 2P+E socket and USB phone charger

Supplied with one USB phone charger output

#### 5 V= 750 mA, to be wired

0540 72*	White RAL 9003 with USB, to be equipped with 1 socket	5658	1
0540 73*	Black RAL 9017 with USB, to be equipped with 1 socket	6162	1



0540 73

0540 73  
+ 0540 62

\* MRP - Maximum Retail Price Inclusive of all taxes including GST.

\* Finishing Plates to be ordered separately

Red Cat.Nos - new products

## Power & data desk grommets for workstation & meeting room table application

Cat.Nos	Description	MRP* ₹ / Unit	Pack
---------	-------------	------------------	------

### Pre-wired modules with retractable cords

For fitting on an empty power & data desktop modules (under the table top)  
Automatic cable rewind when not connected, for an optimized use of the desk surface

#### Cat. 6 FTP

0540 65	Equipped with - 1.35 m RJ 45 Cat. 6 FTP retractable cord on the user side and - 1 x RJ 45 socket on the installation side Patch cord for connection to data network to be ordered separately	3460	1
---------	--	------	---



0540 65

#### USB / micro USB

0540 67	Equipped with - 1.35 m retractable cord with micro USB connector, on the user side and - 0.5 m cable with USB connector on the installation side	3134	1
---------	--	------	---



0540 67

### Finishing plates for empty power & data desk grommets

For fitting on an empty power & data desk grommets

0540 60	White RAL 9003	342	10
0540 62	Black RAL 9017	376	10
0540 63	Stainless steel	1374	10



0540 60



0540 62

### Cable worm

0535 98	2 compartments, Length: 0.75 m White colour very suitable solution for a safe and design protection of the cabling between desk and floor	5414	1
---------	---	------	---



0535 98

## Flush mounting power and data module

A ready to embed solution for all dry support with thickness between 2 and 40 mm. Conform to standard NFC 61-314 which ensures safety of the user  
Aesthetic product (no visible screw), thickness of 6mm only.  
Product available in 8 and 12 module, with the option of configuring power sockets, data, AV, protection etc. 3 Finishes; white/ black and aluminium

### Flush mounting power and data module to be equipped

Aluminium extensions with cable guide (reversible)  
To be equipped with Arteor sockets

#### 8 module; length - 180 mm

0535 60	Flush 8 mod white finish	6154	1
0535 61	Flush 8 mod aluminium finish	7260	1
0535 62	Flush 8 mod black finish	5994	1

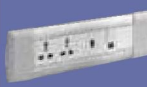

0535 60

#### 12 module; length - 270 mm

0535 63	Flush 12 mod white finish	6474	1
0535 64	Flush 12 mod aluminium finish	7800	1
0535 65	Flush 12 mod black finish	6530	1

Bold Cat.Nos are products normally available with Legrand (India) Stockists. Cat.Nos that are not bold - delivery within 4 - 8 weeks from the date of order. Bold packing quantity is our mandatory packing. Orders to be placed by Legrand (India) Stockist in multiples of the same.

# LBPLUS DATA



## LIGHTING BUSBAR FOR EFFICIENT LIGHTING MANAGEMENT

### SIMPLIFIED INSTALLATION FOR INCREASED PERFORMANCE



#### ENERGY EFFICIENCY

Integrate with dimming systems and lux meters for daytime electricity savings



#### SIMPLICITY WITH COMFORT

Completely addressable system for user convenience and remote management



#### MAXIMUM FLEXIBILITY OF USE

The certified protocols that can be used with LBplus data are the DALI and the 1-10 V protocols.



#### ENVIRONMENT SUSTAINABILITY

With the reduction of energy consumption, there is also an important reduction in the emission of polluting gases in the atmosphere. Renewable energy sources are not the only mean for reaching the environmental sustainability objectives: the starting point is certainly the reduction of existing consumptions



#### ENERGY SAVING

With LBplus data there is a reduction of both energy consumption due to artificial illumination (upto 75%, according to UNIEN 15193), and energy waste, thanks to the automatic management of lighting



#### COMPLIANCE WITH THE STANDARDS

With LBplus data, compliance with the EU Directives on energy efficiency both for new and for refurbished buildings is ensured





## APPLICATIONS / CAN BE USED AT



SHOPPING CENTRES,  
STORES, OFFICES...



WAREHOUSES, GYMS,  
UNDERGROUND car parks...



HOSPITALS,  
LABORATORIES...

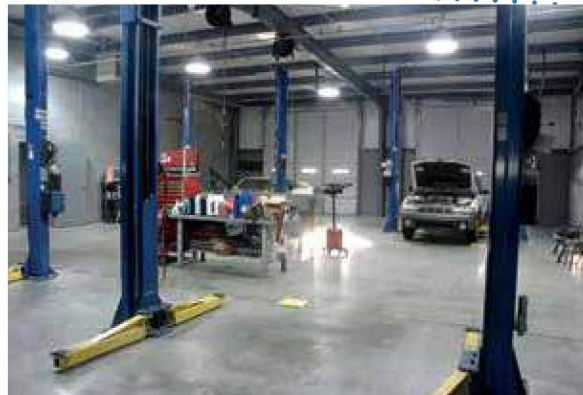

WORKSHOPS, MAINTENANCE & REPAIR  
FACILITIES, PRODUCTION SITES...



Scan to know more about  
the product.



# IP68 RCP

## RESIN BUSBAR TRUNKINGS



## A SOLUTION THAT ADAPTS TO INDOOR AND OUTDOOR INSTALLATIONS

The **RCP IP68** resin busbar trunking system is a solution mainly for outdoor in extreme conditions such as humidity, corrosion or saline mist environment and temporary immersion risks.

### RCP IP68 Resin Busbar

New resin busbar RCP with range from 630 A to 6300 A and IP68 degree of protection represents the complete solution for the **transport** of high-power energy.

This new product is made with internal conductors in aluminium or copper and completely embedded in a **epoxy resin**, which provides mechanical strength and electrical insulation. With RCP is possible to provide specific solutions in different environments (outdoor and indoor) where it isn't possible to reach with busbar IP55.



Scan to know more about the product.

## DEGREE OF PROTECTION

# IP68

### 1ST DIGIT IP

Protection against penetration of solid bodies

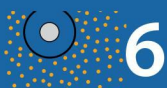

# 6

Complete protection against dust

### 2ND DIGIT IP

Protection against penetration of liquids



# 8

Protection against effects of Immersion under pressure

(At maximum of 1m, as comply by standard EN 61439-6)

## BUSBAR TRUNKING

- Resin built-in conductors.
- Insulations of single conductors in polyester film.
- Fully insulated with epoxy resin.
- Rated current between 630 - 6300 A.
- Insulation voltage up to 1000 V.
- Small dimensions.
- Maintenance free.
- Only for Transport of energy.

## CONDUCTOR MATERIAL

- Copper: copper busbars with a purity greater than 99.9% .
- Aluminium: aluminium alloy busbars, with entire surface treated with different galvanic processes.
- Degree of protection: IP68 according to the EN 61439-6.

## Typical applications

The typical applications of IP68 busbar trunkings are



Industrial plants



Petrochemical plants



Chemical plants (\*).



Outdoor (in different extreme conditions).

(\*): attention at chemical components which are not compatible with the busbar's resin